

548433 FAG

Tapered roller bearings

TYPE: Roller bearings, Tapered, Double row, With extended cones, design 1 (FAG)

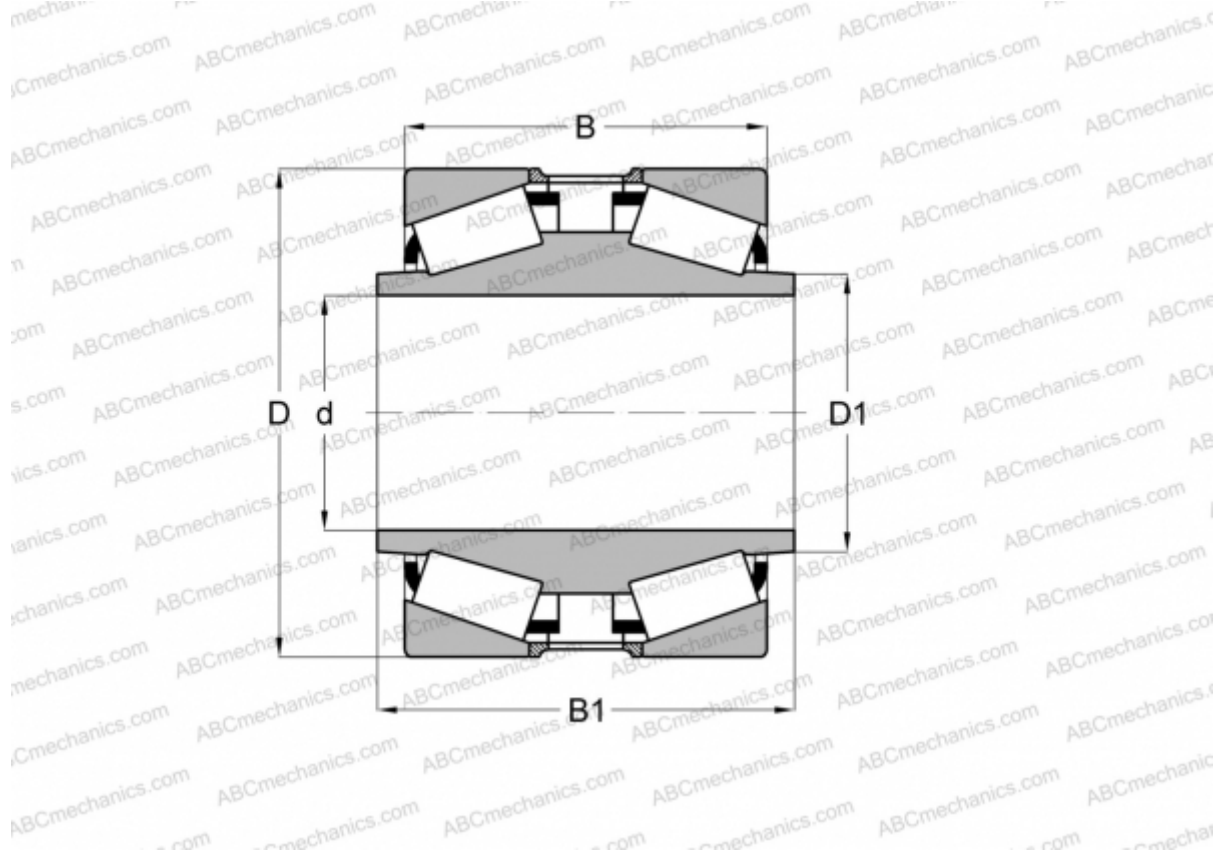

Technical specification

DIMENSIONS, MM

d	160,000
D	240,000
D1	175,000
B	94,000
B1	145,000

WEIGHT, KG 17,000

MANUFACTURER [FAG](#)