

548245 FAG

Tapered roller bearings

TYPE: Roller bearings, Tapered, Double row, With extended cones, design 1 (FAG)

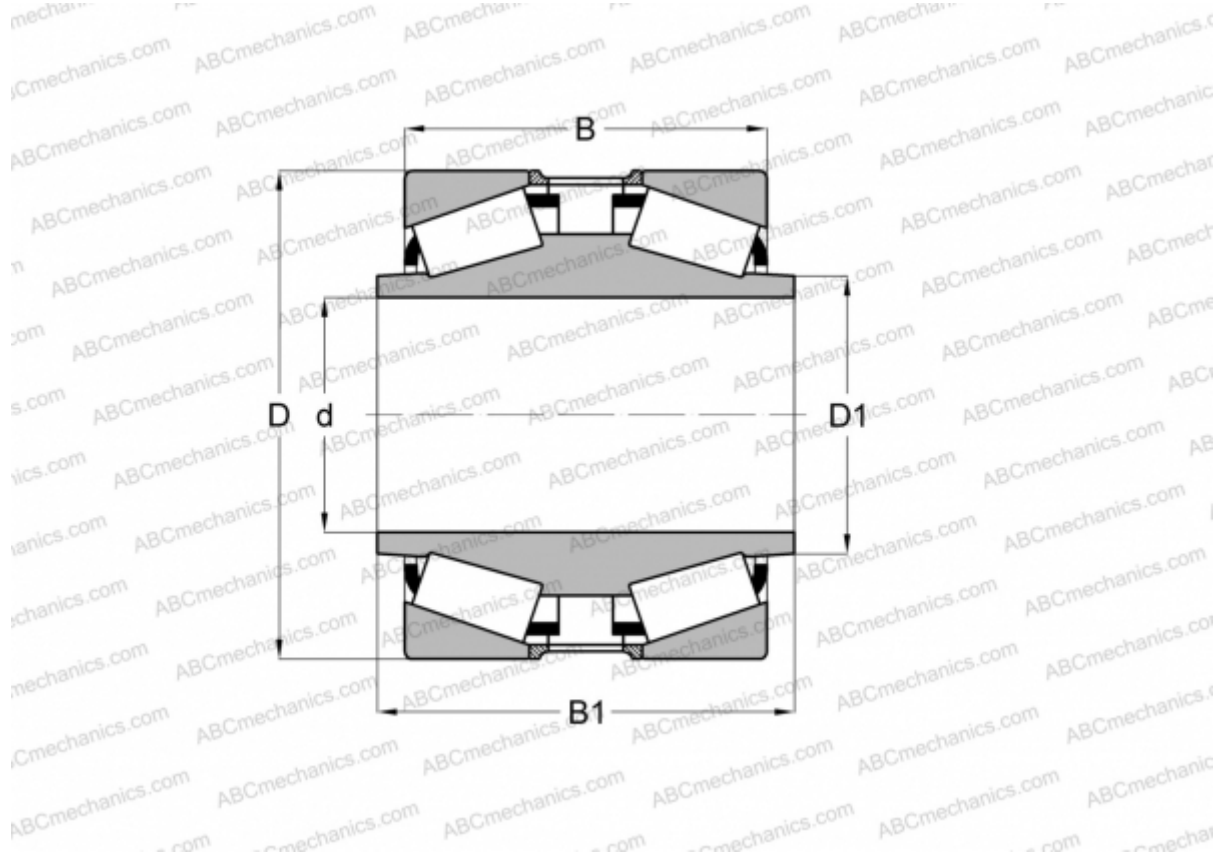

Technical specification

DIMENSIONS, MM

d	187,325
D	269,875
D1	202,184
B	101,600
B1	160,338

WEIGHT, KG 22,000

MANUFACTURER [FAG](#)