

## 564286 FAG

Tapered roller bearings

TYPE: Roller bearings, Tapered, Double row, With extended cones, design 1 (FAG)

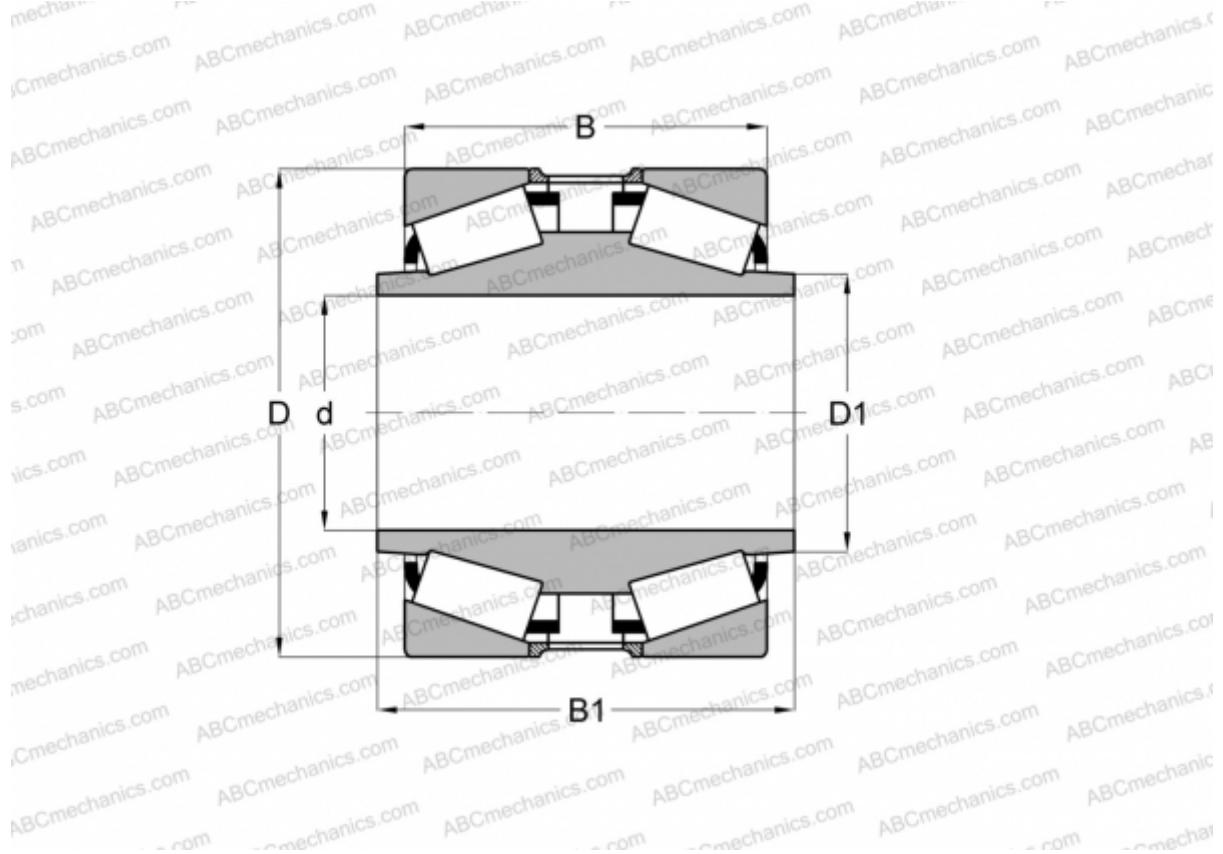

### Technical specification

#### DIMENSIONS, MM

d	187,325
D	290,000
D1	206,375
B	142,000
B1	192,000

**WEIGHT, KG** 38,000

**MANUFACTURER** [FAG](#)