

## 535081 FAG

Tapered roller bearings

TYPE: Roller bearings, Tapered, Double row, With extended cones, design 1 (FAG)

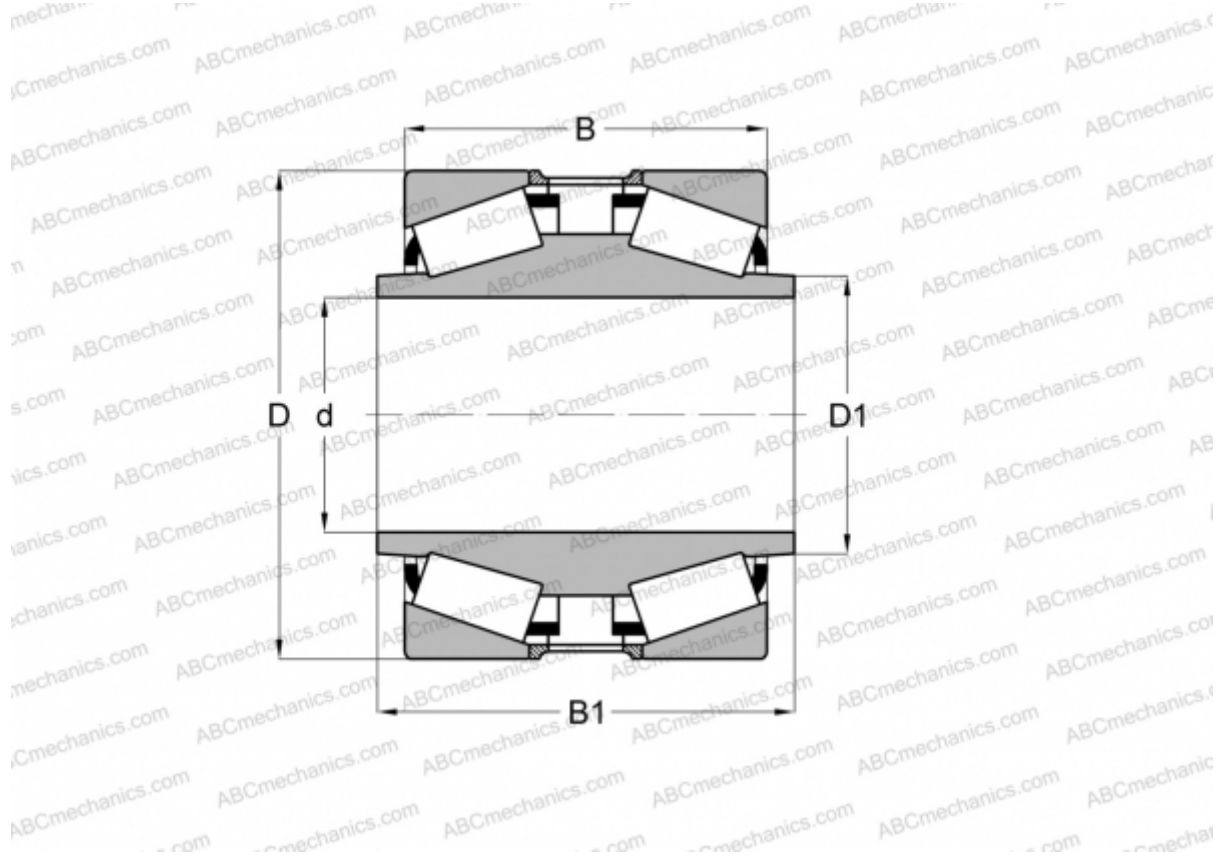

### Technical specification

#### DIMENSIONS, MM

d	269,875
D	381,000
D1	292,100
B	136,525
B1	196,850

**WEIGHT, KG** 52,500

**MANUFACTURER** [FAG](#)