

548243 FAG

Tapered roller bearings

TYPE: Roller bearings, Tapered, Double row, With extended cones, design 1 (FAG)

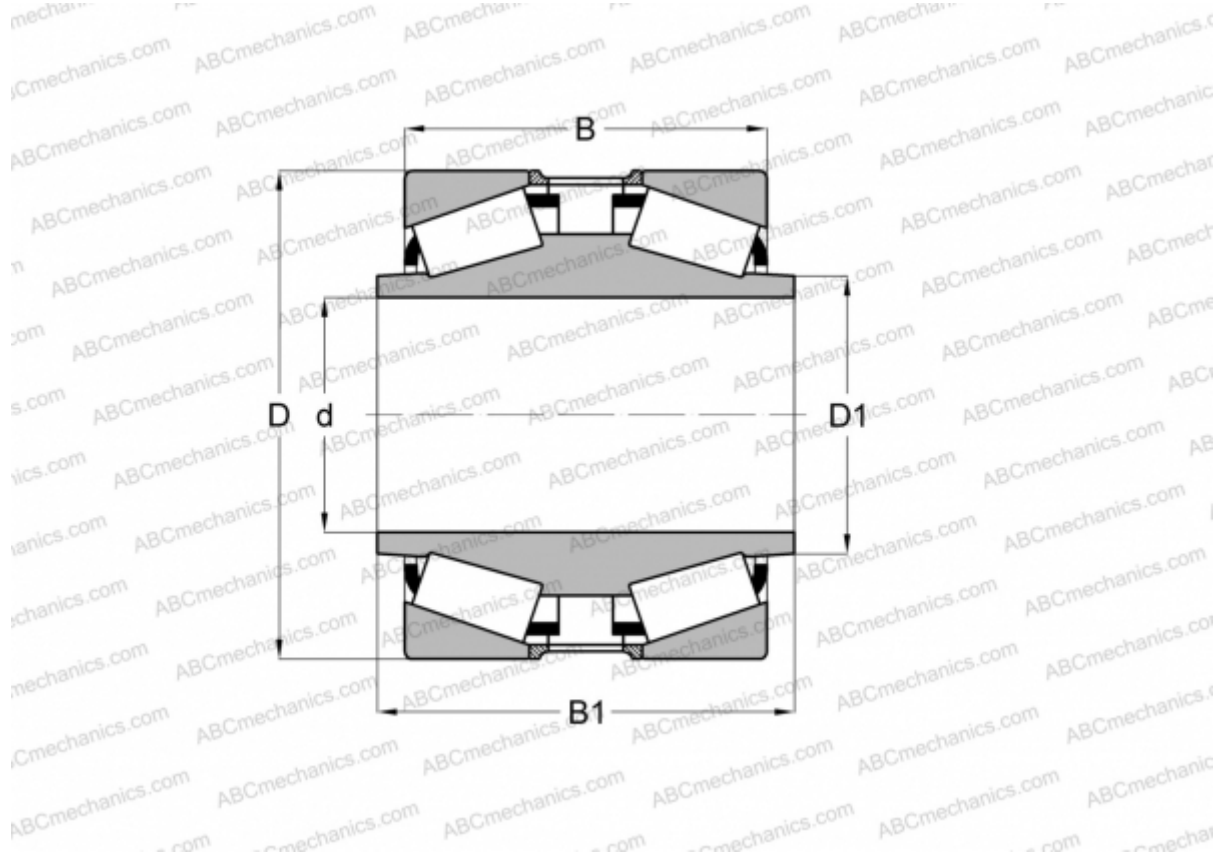

Technical specification

DIMENSIONS, MM

d	288,925
D	406,400
D1	307,975
B	165,100
B1	234,950

WEIGHT, KG 74,000

MANUFACTURER [FAG](#)