

544752 FAG

Tapered roller bearings

TYPE: Roller bearings, Tapered, Double row, With extended cones, tapered bore (1:12), design 2 (FAG)

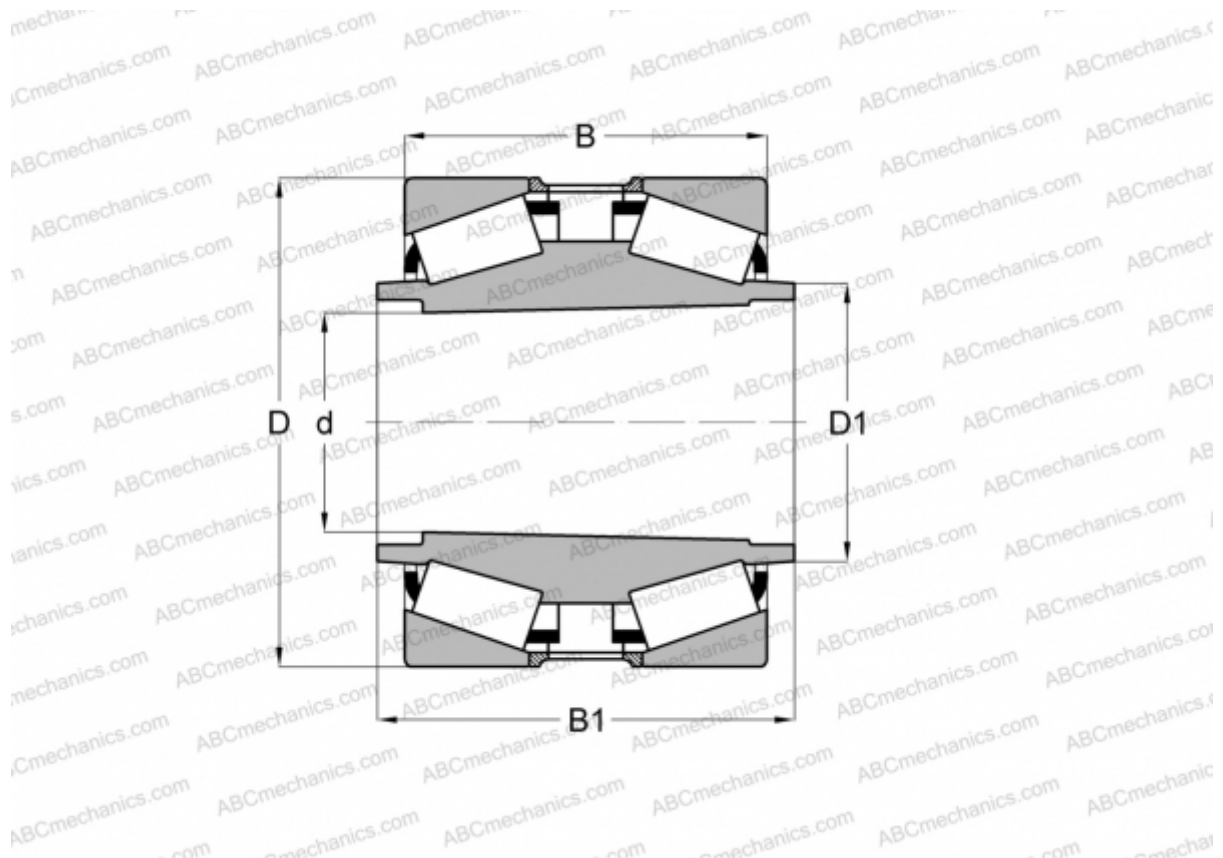

Technical specification

DIMENSIONS, MM

d	177,800
D	269,875
D1	193,675
B	139,700
B1	184,150

WEIGHT, KG 36,000

MANUFACTURER [FAG](#)