

542048 FAG

Tapered roller bearings

TYPE: Roller bearings, Tapered, Double row, With extended cones, tapered bore (1:12), design 2 (FAG)

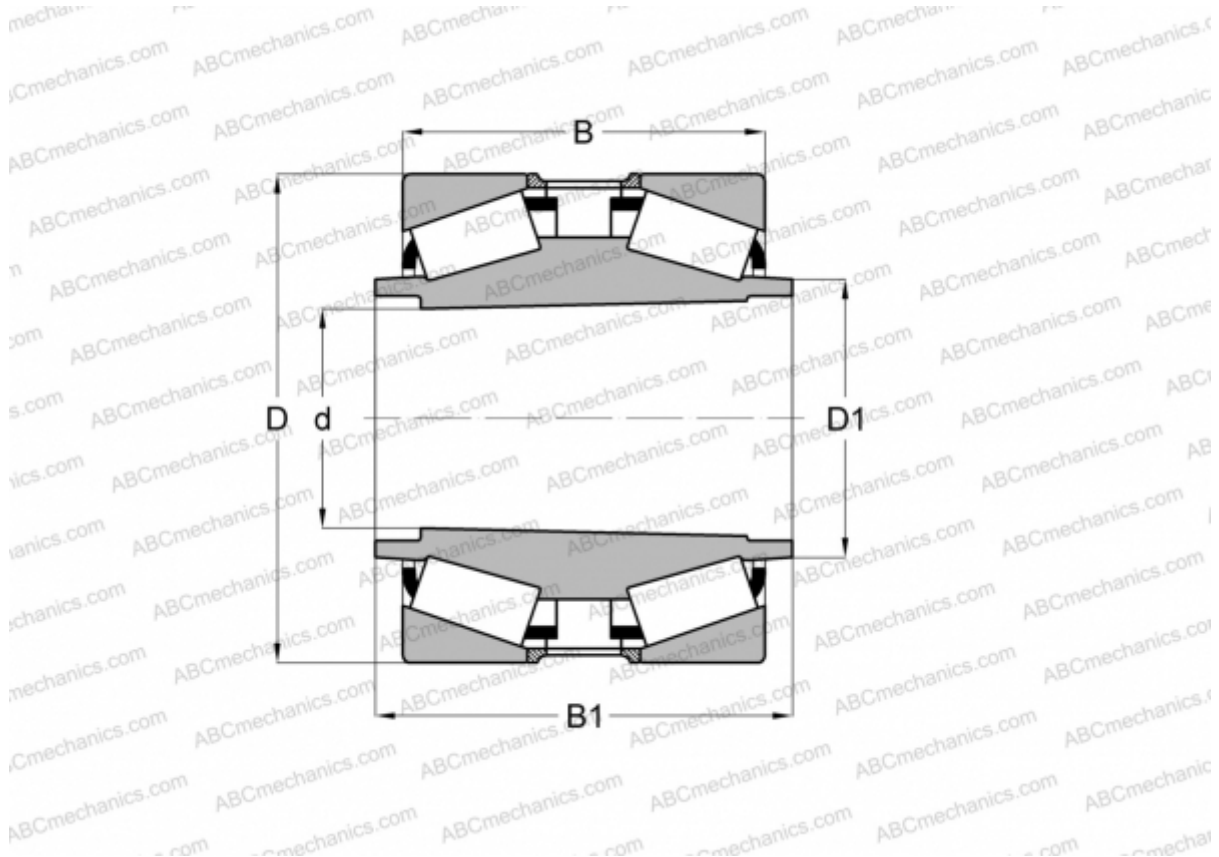

Technical specification

DIMENSIONS, MM

d	190,000
D	290,000
D1	206,375
B	142,000
B1	192,000

WEIGHT, KG 38,000

MANUFACTURER [FAG](#)