

564232 FAG

Tapered roller bearings

TYPE: Roller bearings, Tapered, Double row, With extended cones, tapered bore (1:12), design 2 (FAG)

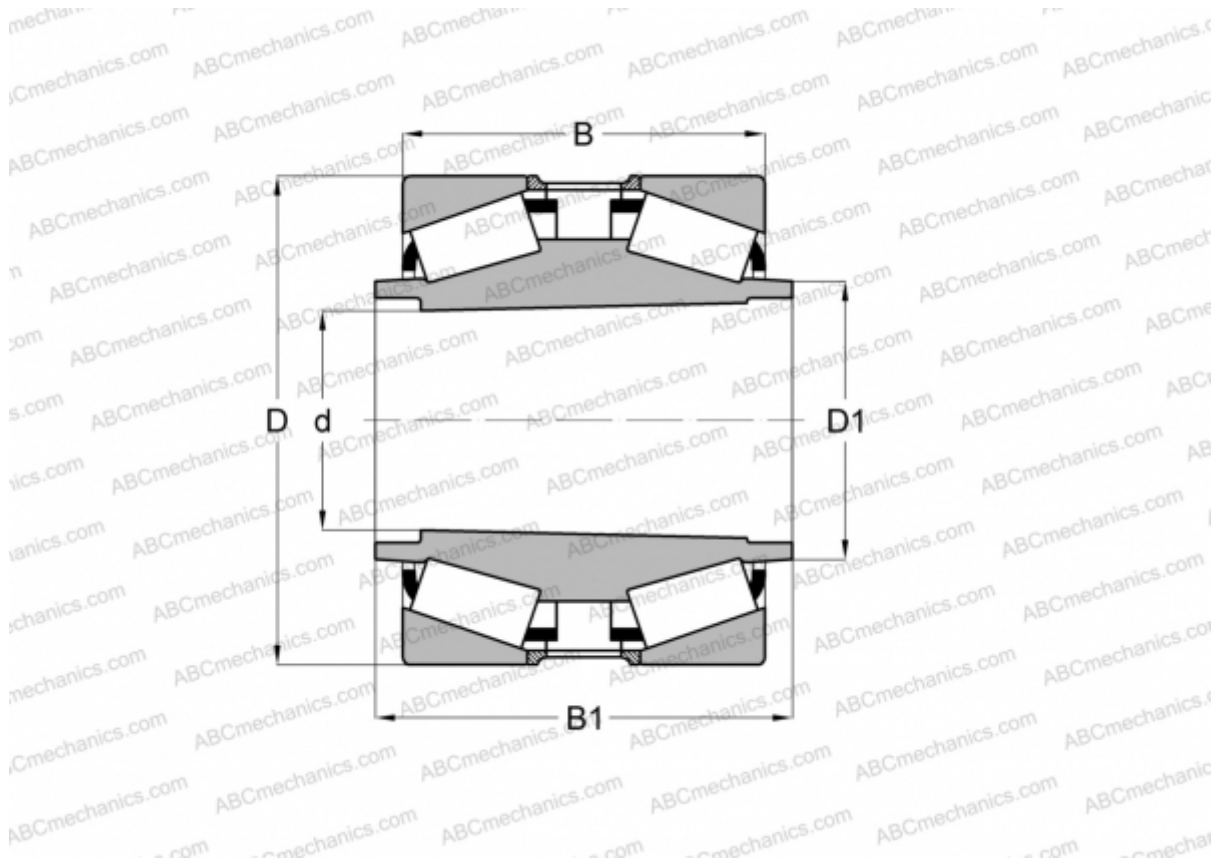

Technical specification

DIMENSIONS, MM

d	220,000
D	340,000
D1	241,300
B	140,000
B1	200,000

WEIGHT, KG 55,000

MANUFACTURER [FAG](#)