

## 542129 FAG

Tapered roller bearings

TYPE: Roller bearings, Tapered, Double row, With extended cones, tapered bore (1:12), design 2 (FAG)

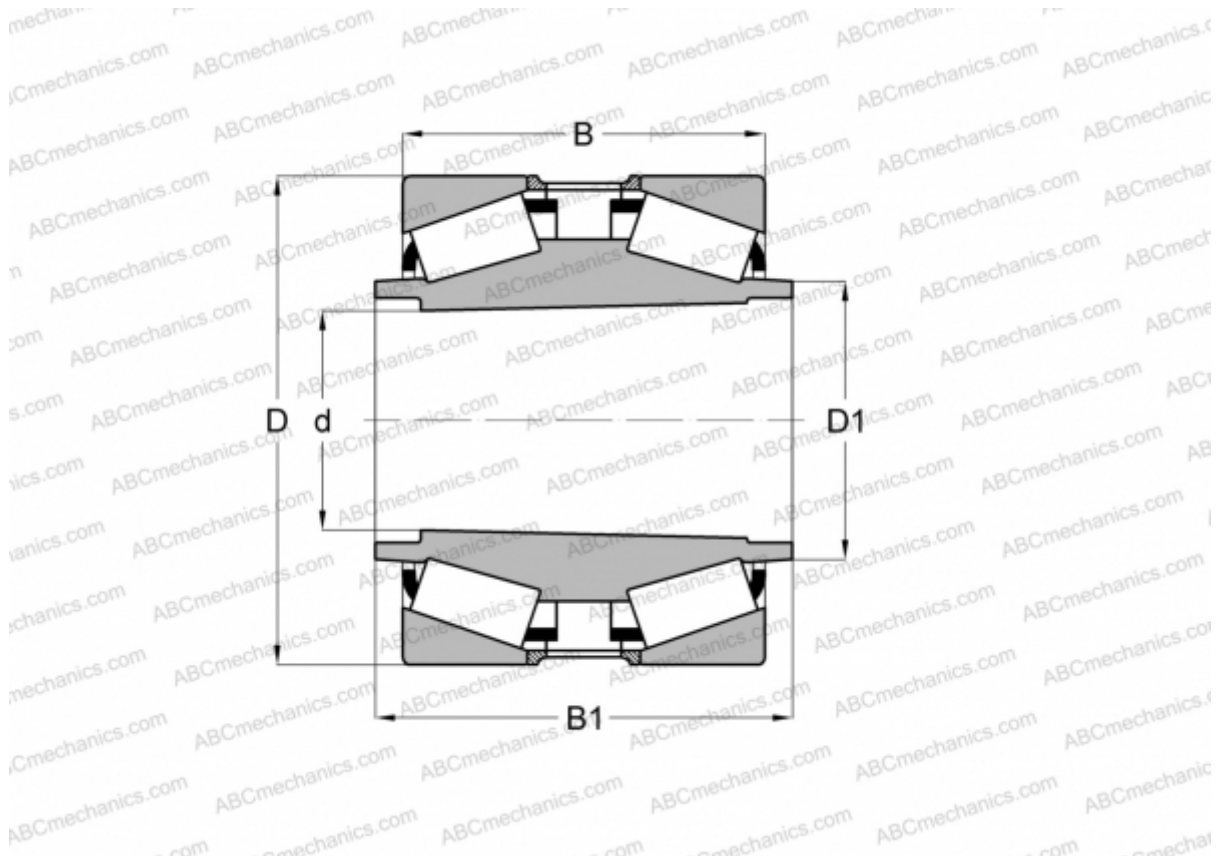

### Technical specification

#### DIMENSIONS, MM

d	220,130
D	336,550
D1	241,300
B	180,975
B1	244,475

**WEIGHT, KG** 62,000

**MANUFACTURER** [FAG](#)