

## 539574 FAG

Tapered roller bearings

TYPE: Roller bearings, Tapered, Double row, With extended cones, tapered bore (1:12), design 2 (FAG)

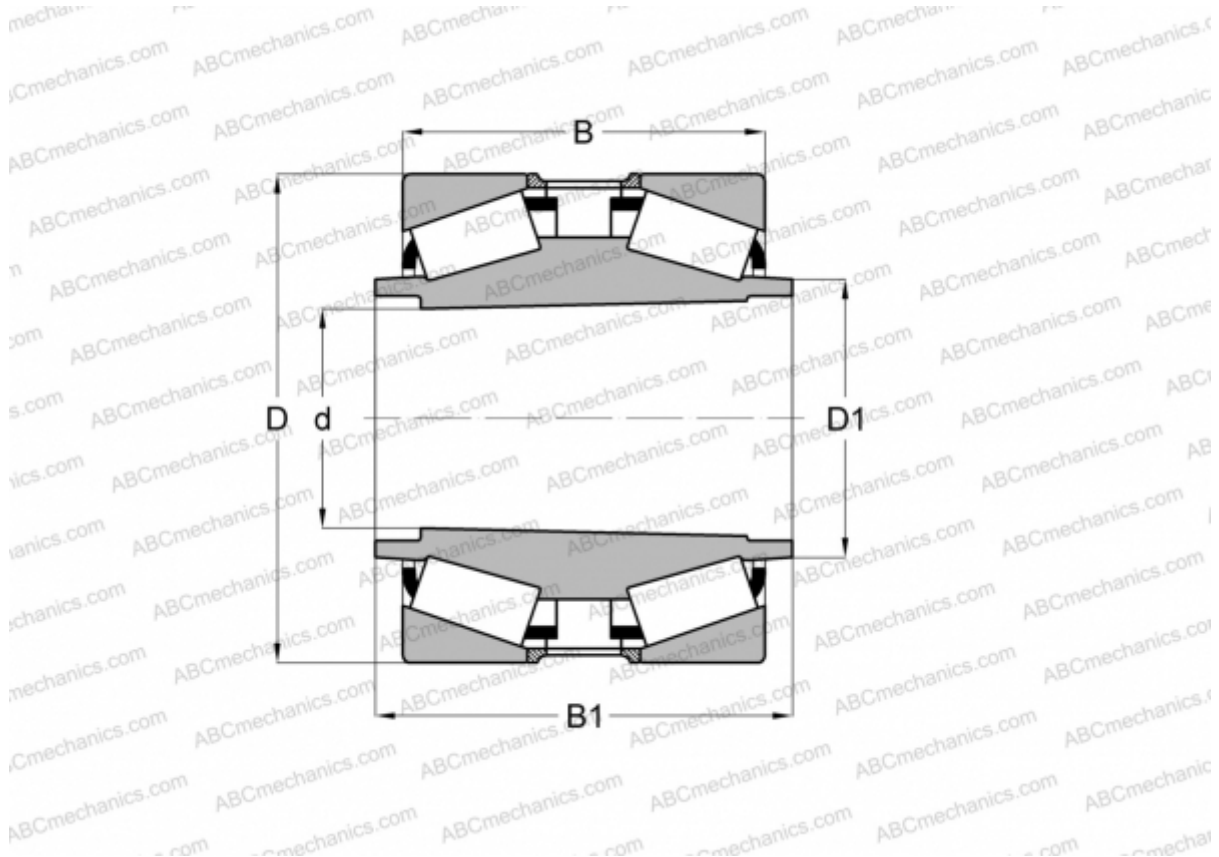

### Technical specification

#### DIMENSIONS, MM

d	230,000
D	370,000
D1	260,350
B	160,000
B1	223,500

**WEIGHT, KG** 77,000

**MANUFACTURER** [FAG](#)