

542146 FAG

Tapered roller bearings

TYPE: Roller bearings, Tapered, Double row, With extended cones, tapered bore (1:12), design 2 (FAG)

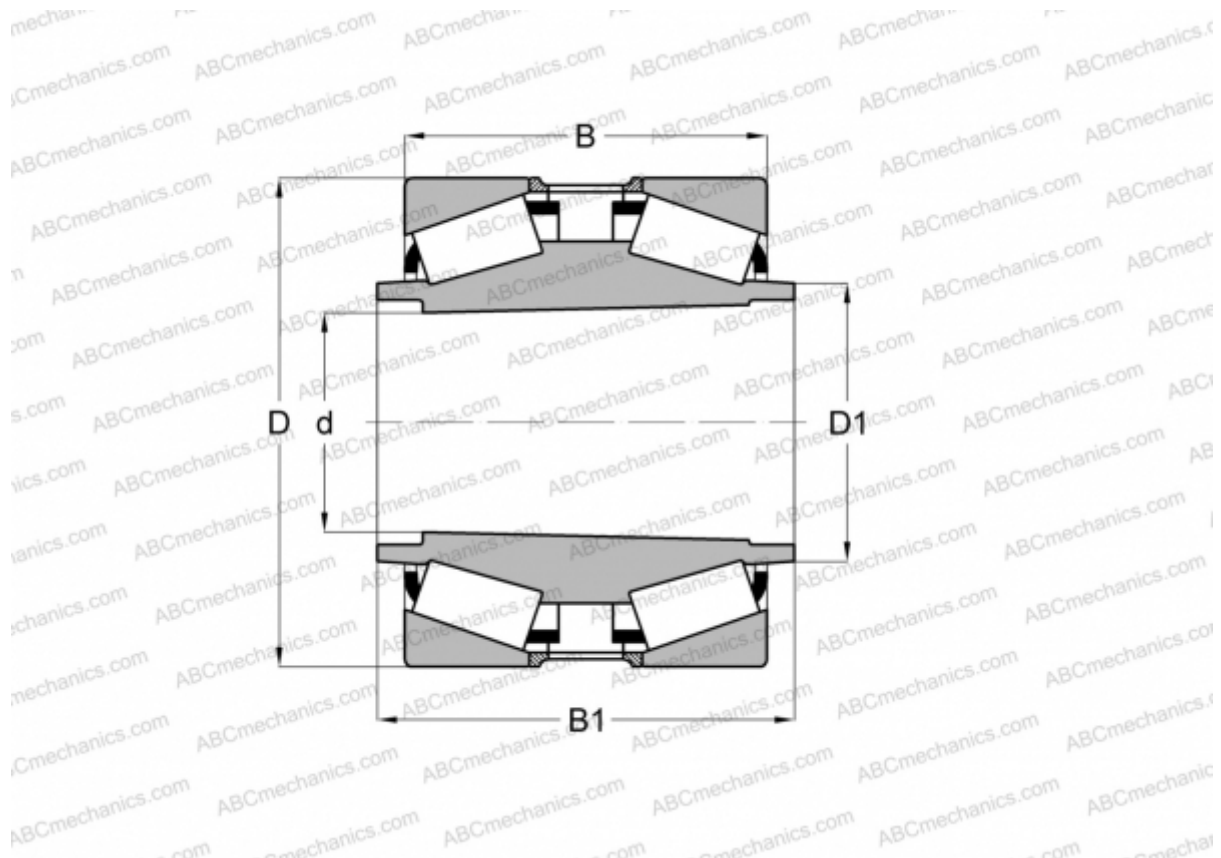

Technical specification

DIMENSIONS, MM

d	272,390
D	381,000
D1	292,100
B	136,525
B1	196,850

WEIGHT, KG 56,000

MANUFACTURER [FAG](#)