

539576 FAG

Tapered roller bearings

TYPE: Roller bearings, Tapered, Double row, With extended cones, tapered bore (1:12), design 2 (FAG)

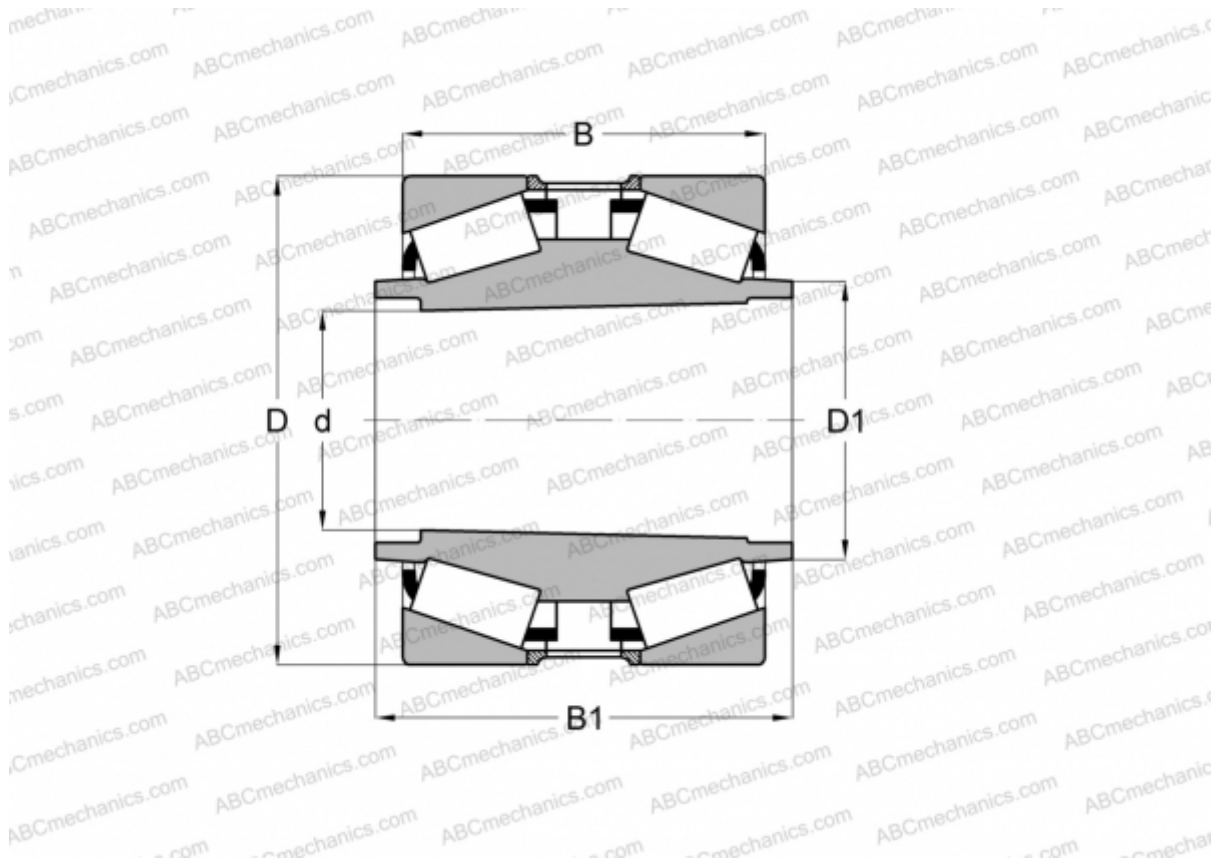

Technical specification

DIMENSIONS, MM

d	317,500
D	447,675
D1	342,900
B	159,512
B1	222,250

WEIGHT, KG 92,000

MANUFACTURER [FAG](#)