

564230 FAG

Tapered roller bearings

TYPE: Roller bearings, Tapered, Double row, With extended cones, tapered bore (1:12), design 2 (FAG)

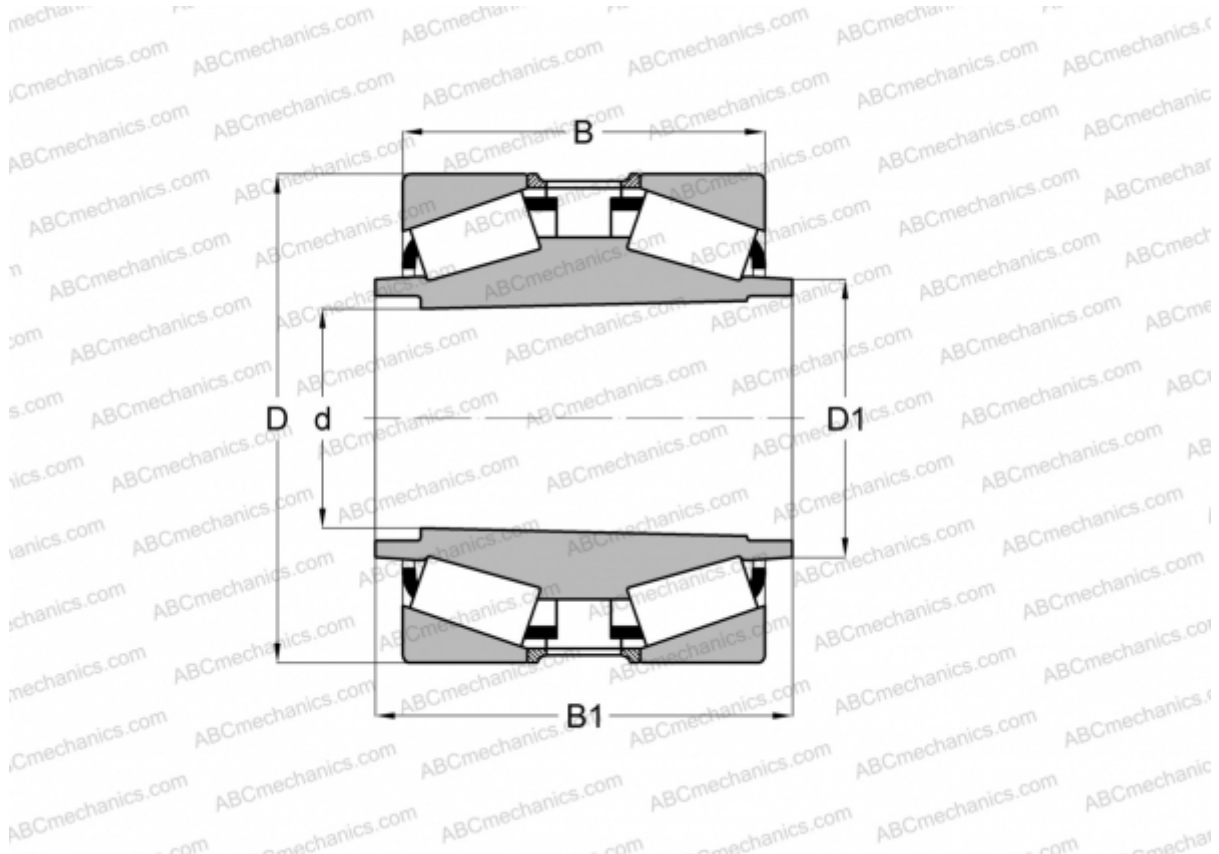

Technical specification

DIMENSIONS, MM

d	333,375
D	469,900
D1	355,600
B	166,688
B1	231,775

WEIGHT, KG 102,000

MANUFACTURER [FAG](#)