

## 541965 FAG

Tapered roller bearings

TYPE: Roller bearings, Tapered, Double row, With extended cones, tapered bore (1:12), design 2 (FAG)

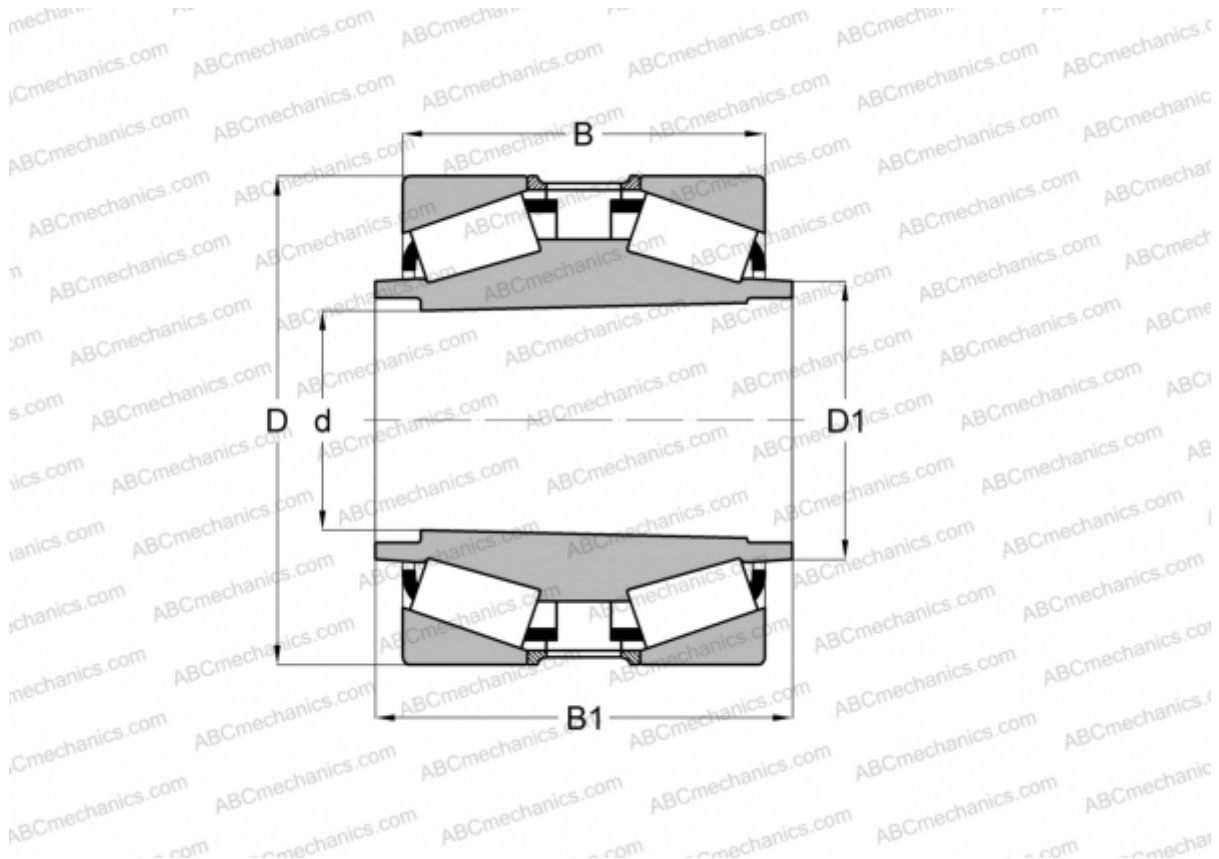

### Technical specification

#### DIMENSIONS, MM

d	333,375
D	469,900
D1	355,600
B	182,563
B1	247,650

**WEIGHT, KG** 115,000

**MANUFACTURER** [FAG](#)