

544754 FAG

Tapered roller bearings

TYPE: Roller bearings, Tapered, Double row, With extended cones, tapered bore (1:12), design 2 (FAG)

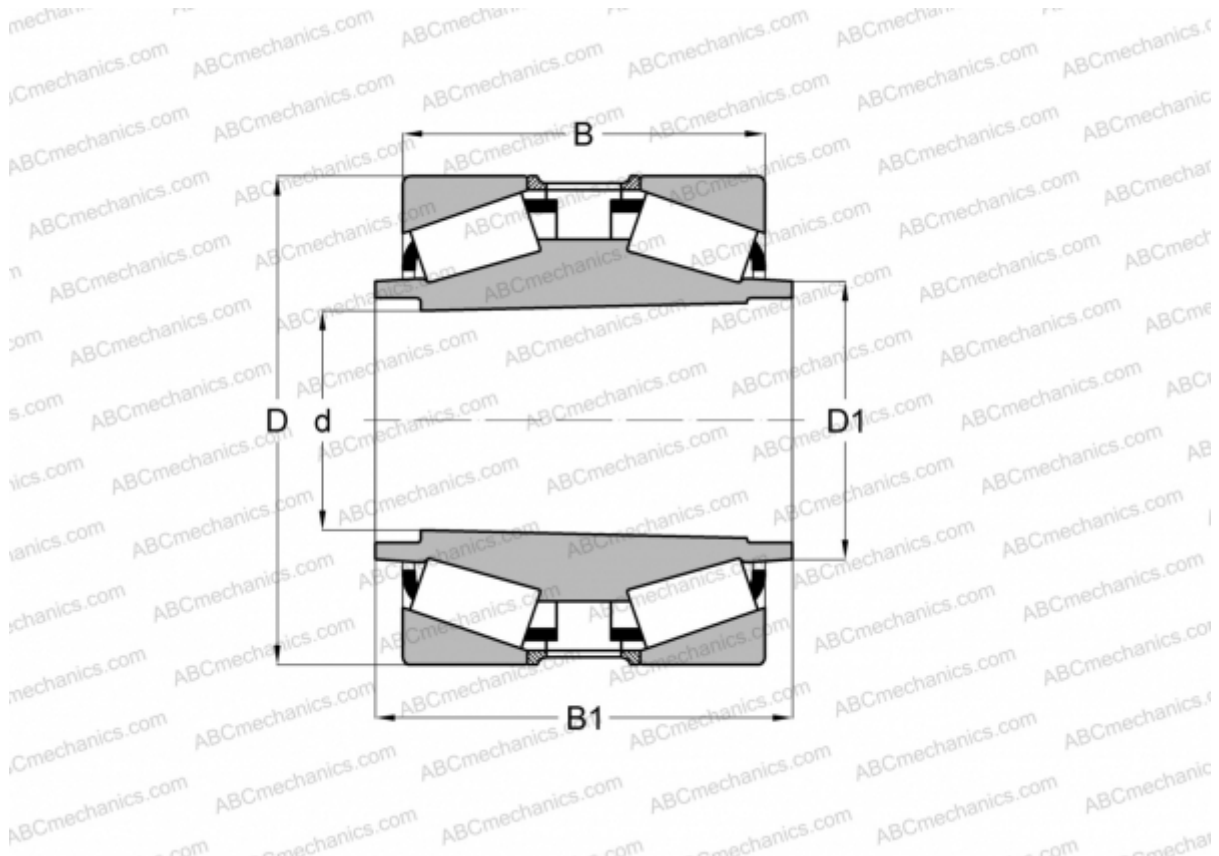

Technical specification

DIMENSIONS, MM

d	340,000
D	520,000
D1	371,475
B	220,000
B1	280,000

WEIGHT, KG 228,000

MANUFACTURER [FAG](#)