

## HM926740.710D TIMKEN

Tapered roller bearings

TYPE: Roller bearings, Tapered, Double row, O-arrangement, inch size, design 1 (FAG)

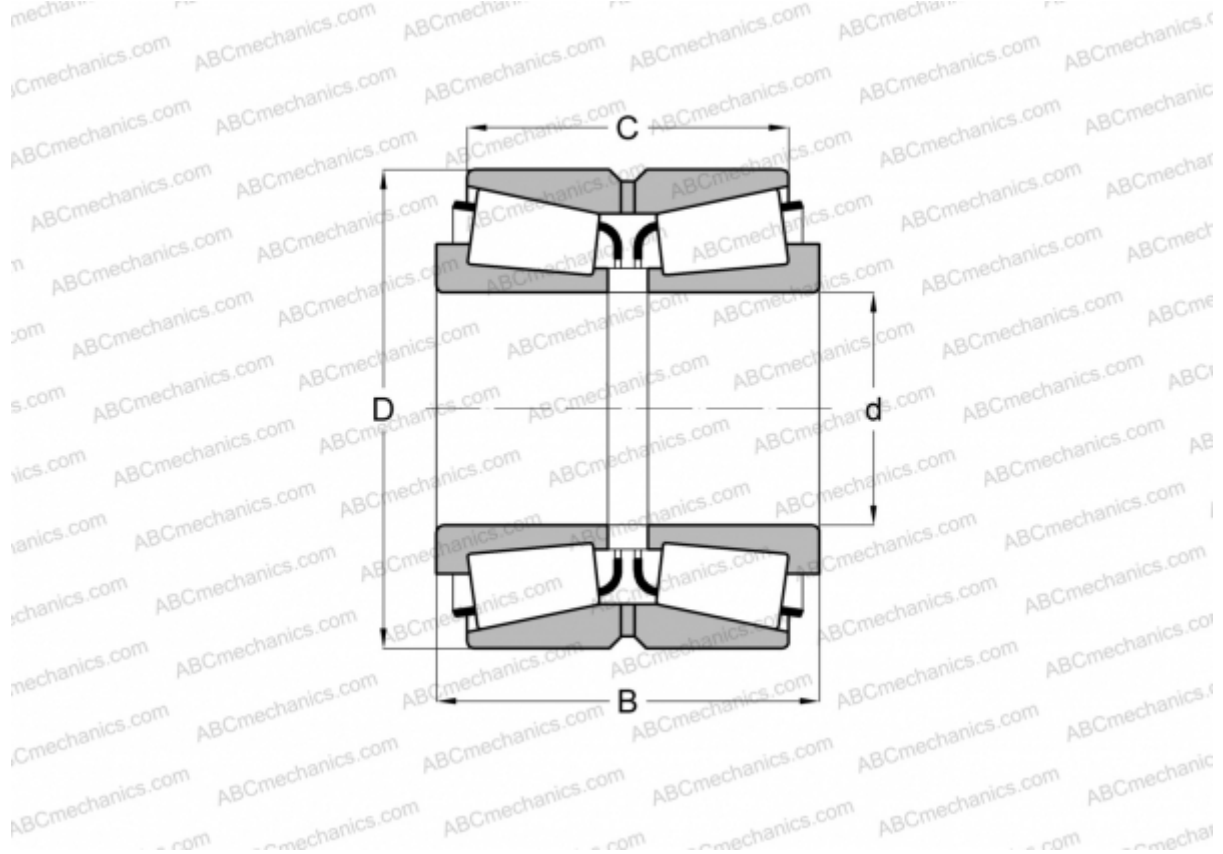

### Technical specification

#### DIMENSIONS, MM

d	114,300
D	228,600
B	115,888
C	84,138

**WEIGHT, KG** 22,000

**MANUFACTURER** [TIMKEN](#)

#### INTERCHANGE

FAG [515090](#)