

## HM237535.510D TIMKEN

Tapered roller bearings

TYPE: Roller bearings, Tapered, Double row, O-arrangement, inch size, design 1 (FAG)

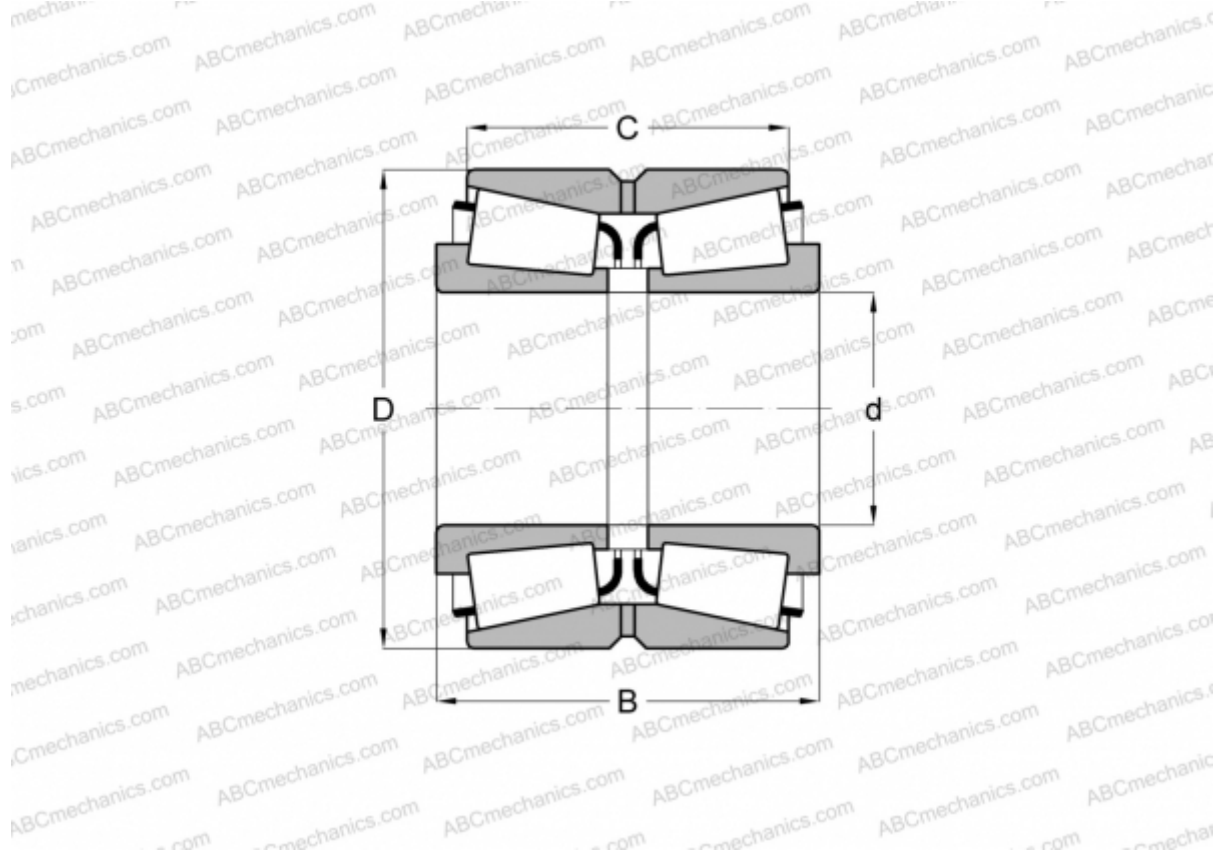

### Technical specification

#### DIMENSIONS, MM

d	165,100
D	288,925
B	142,875
C	111,125

**WEIGHT, KG** 36,800

**MANUFACTURER** [TIMKEN](#)

#### INTERCHANGE

FAG [522040](#)