

M238849.810D TIMKEN

Tapered roller bearings

TYPE: Roller bearings, Tapered, Double row, O-arrangement, inch size, design 1 (FAG)

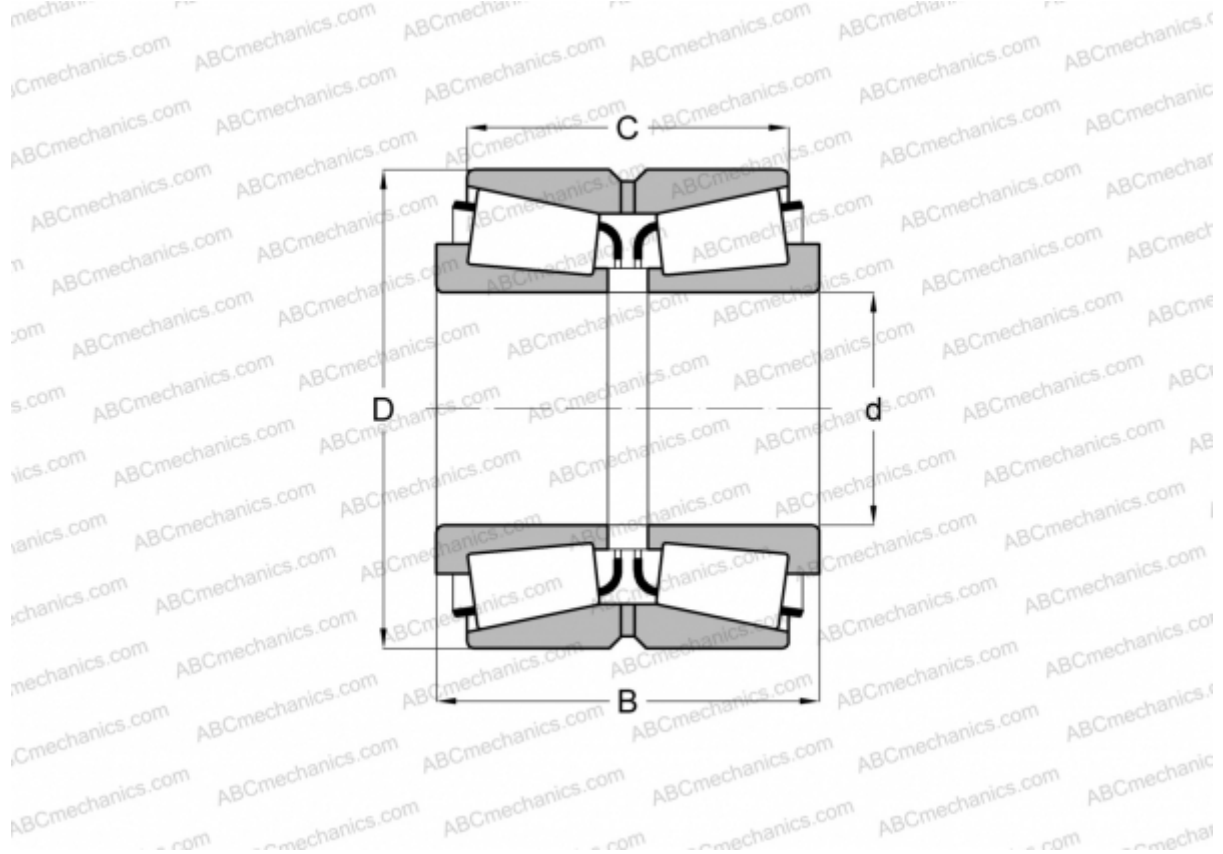

Technical specification

DIMENSIONS, MM

d	187,325
D	269,875
B	119,062
C	93,662

WEIGHT, KG 20,800

MANUFACTURER [TIMKEN](#)

INTERCHANGE

FAG [525012](#)