

HM252349.310D TIMKEN

Tapered roller bearings

TYPE: Roller bearings, Tapered, Double row, O-arrangement, inch size, design 1 (FAG)

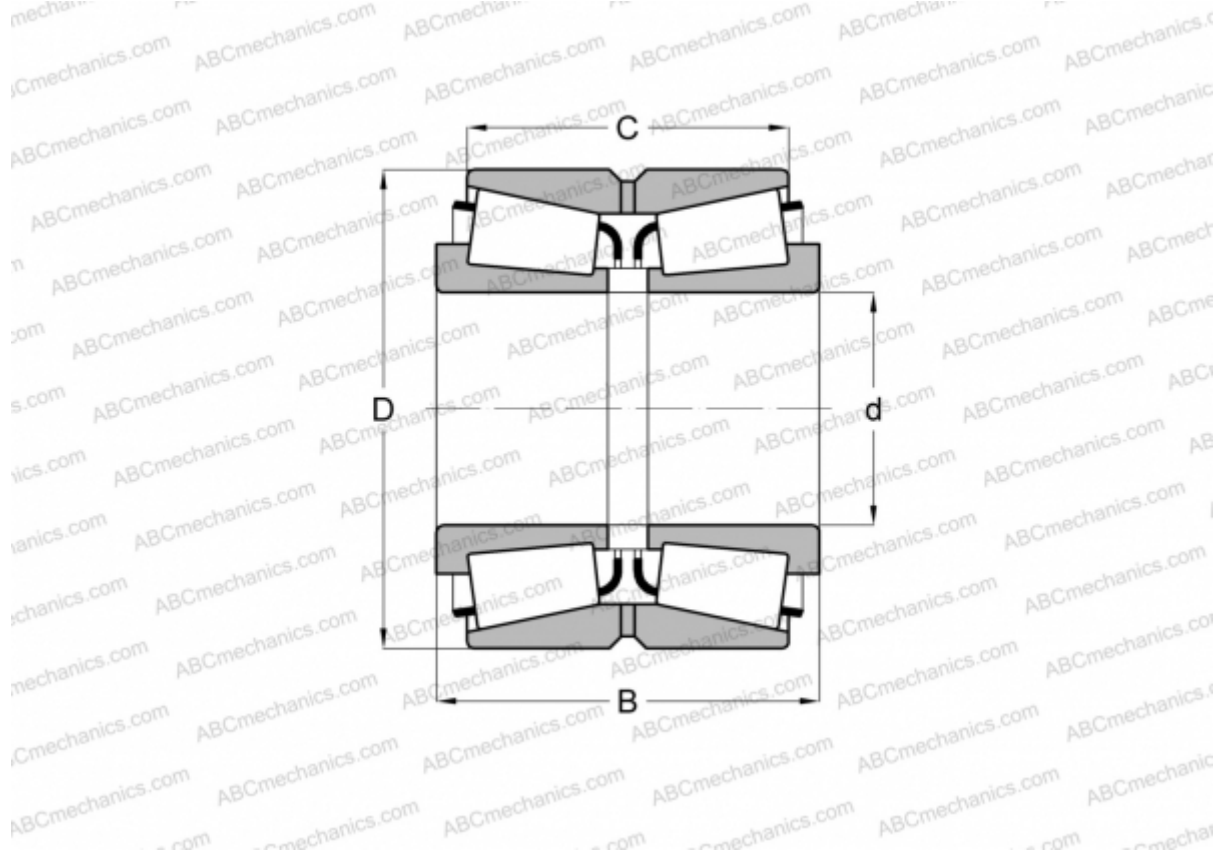

Technical specification

DIMENSIONS, MM

d	260,350
D	422,275
B	178,592
C	139,700

WEIGHT, KG 86,800

MANUFACTURER [TIMKEN](#)

INTERCHANGE

FAG [514599](#)