

EE147112.198D TIMKEN

Tapered roller bearings

TYPE: Roller bearings, Tapered, Double row, O-arrangement, inch size, design 1 (FAG)

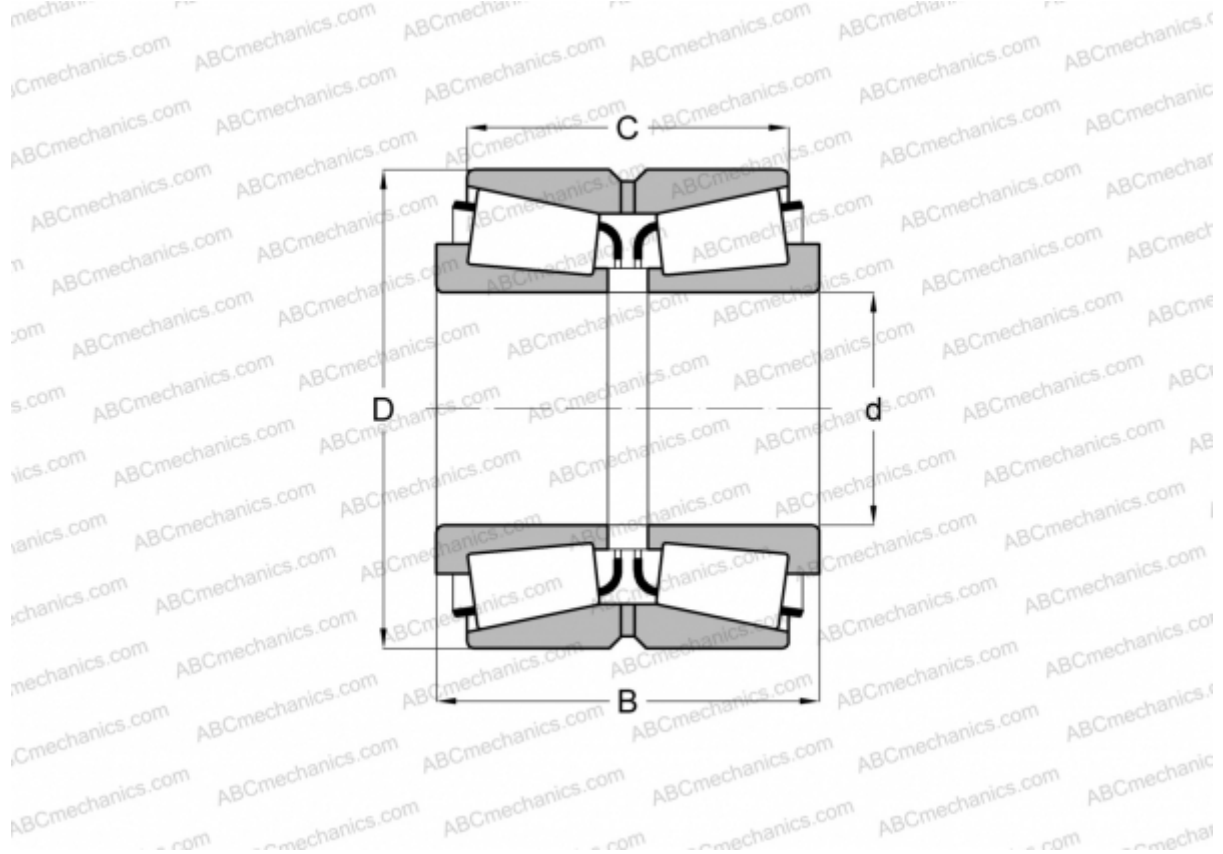

Technical specification

DIMENSIONS, MM

d	285,750
D	501,650
B	203,200
C	120,650

WEIGHT, KG 143,000

MANUFACTURER [TIMKEN](#)

INTERCHANGE

FAG [525830](#)