

EE148122.220D TIMKEN

Tapered roller bearings

TYPE: Roller bearings, Tapered, Double row, O-arrangement, inch size, design 1 (FAG)

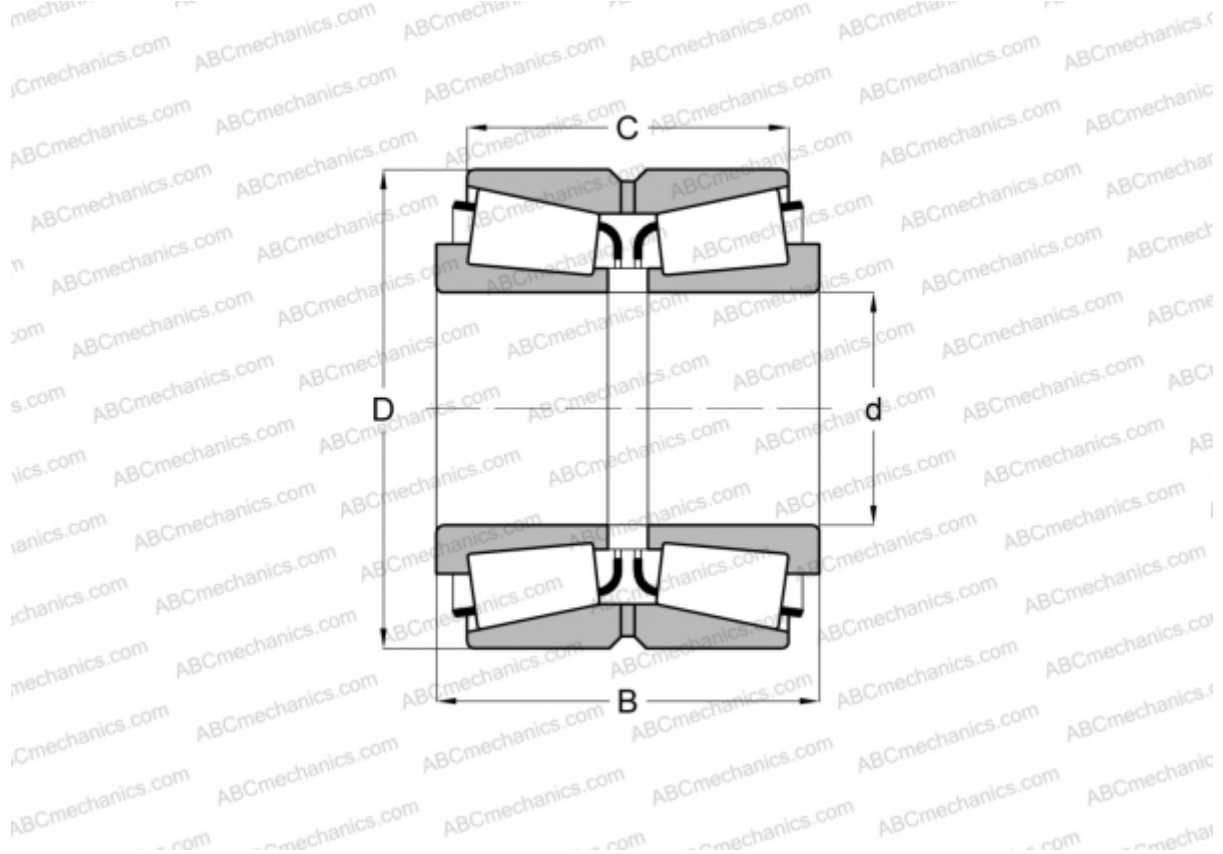

Technical specification

DIMENSIONS, MM

d	311,150
D	558,800
B	190,500
C	111,125

WEIGHT, KG 172,000

MANUFACTURER [TIMKEN](#)

INTERCHANGE

FAG [512601](#)