

521233 FAG

Tapered roller bearings

TYPE: Roller bearings, Tapered, Double row, O-arrangement, inch size, design 1 (FAG)

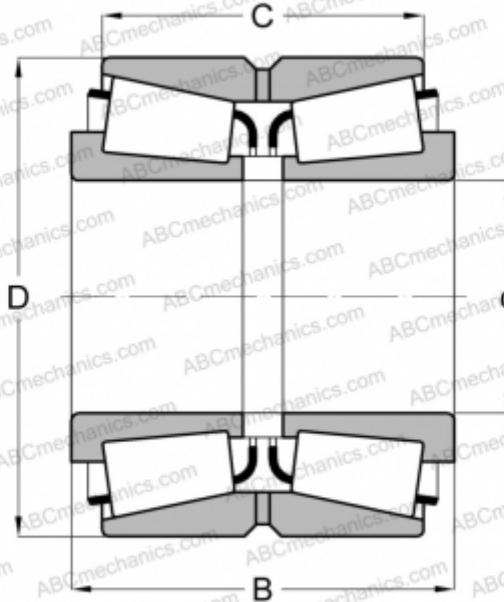

Technical specification

DIMENSIONS, MM

d	711,200
D	914,400
B	190,500
C	139,700

WEIGHT, KG 285,000

MANUFACTURER [FAG](#)

INTERCHANGE

TIMKEN [EE755280.361D](#)