

EE762320.420D TIMKEN

Tapered roller bearings

TYPE: Roller bearings, Tapered, Double row, O-arrangement, inch size, design 1 (FAG)

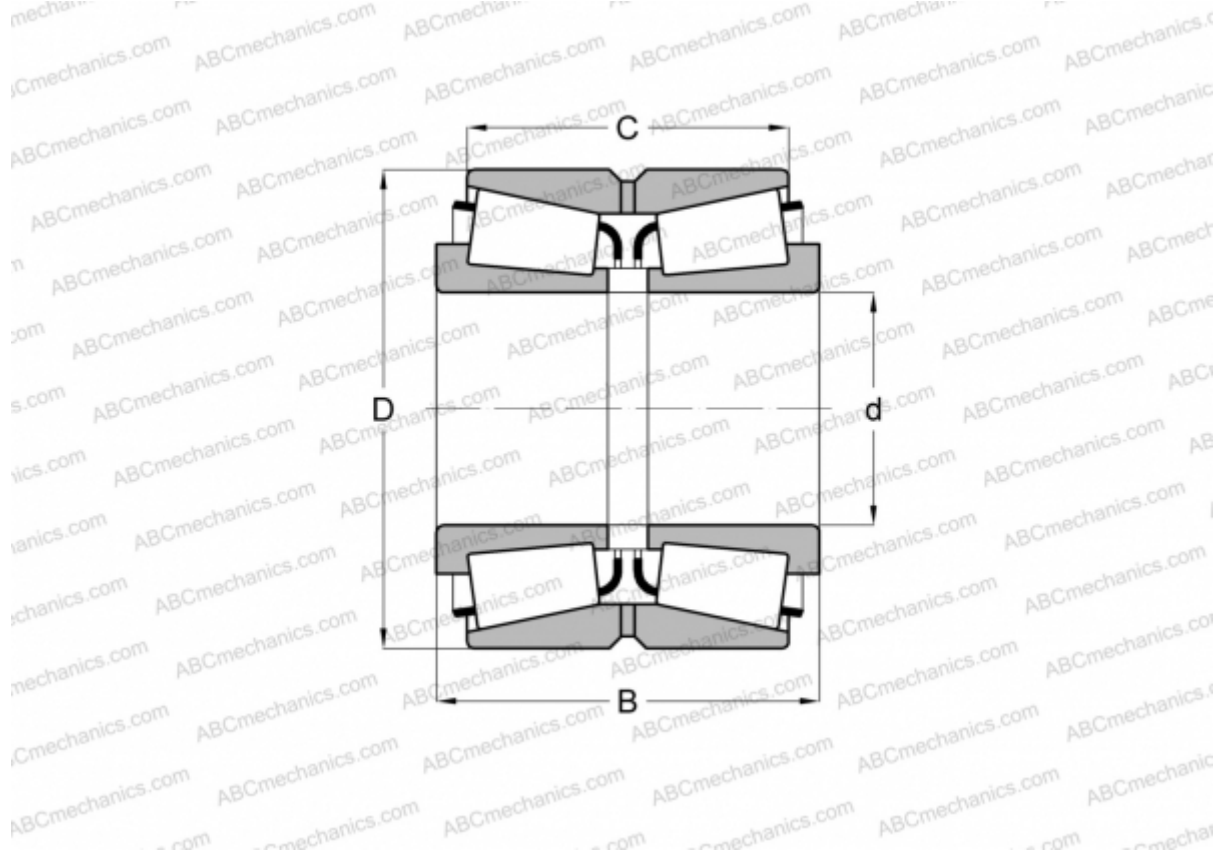

Technical specification

DIMENSIONS, MM

d	812,800
D	1066,800
B	190,500
C	146,050

WEIGHT, KG 430,000

MANUFACTURER [TIMKEN](#)

INTERCHANGE

FAG [518817](#)