

562080 FAG

Tapered roller bearings

TYPE: Roller bearings, Tapered, Double row, O-arrangement, inch size, design 2 (FAG)

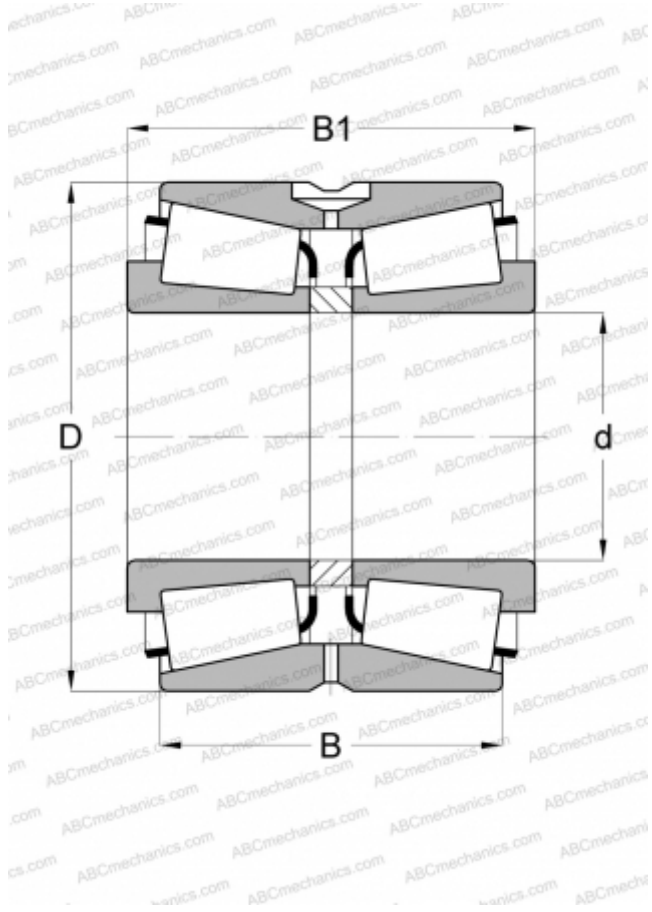

Technical specification

DIMENSIONS, MM

d	146,050
D	254,000
B	149,225
C	111,125

WEIGHT, KG

29,700

MANUFACTURER

[FAG](#)

INTERCHANGE

TIMKEN

[99575.102CD](#)