

503594 FAG

Tapered roller bearings

TYPE: Roller bearings, Tapered, Double row, O-arrangement, inch size, design 2 (FAG)

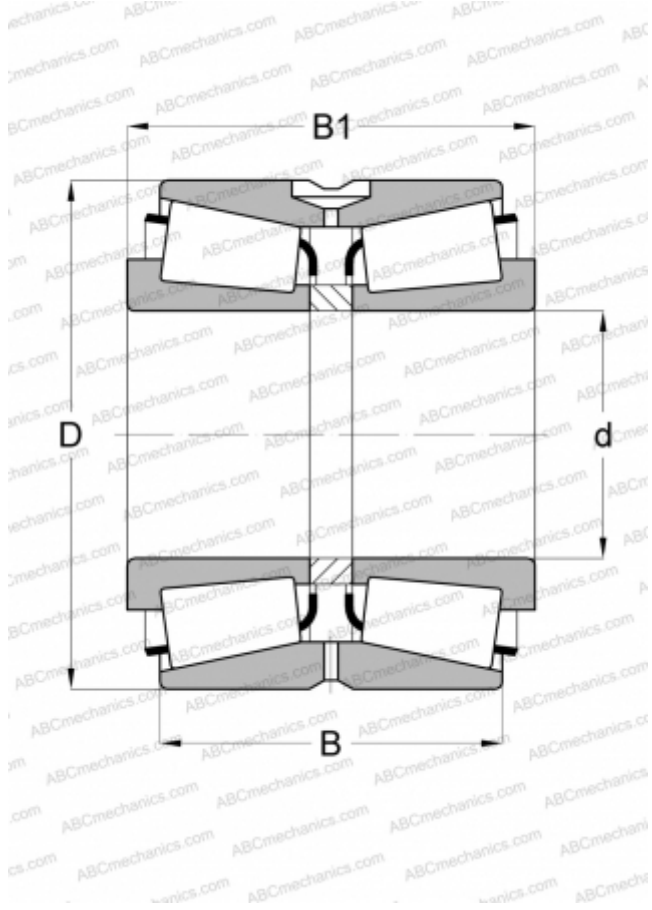

Technical specification

DIMENSIONS, MM

d	177,800
D	288,925
B	142,875
C	111,125

WEIGHT, KG

33,600

MANUFACTURER

[FAG](#)

INTERCHANGE

TIMKEN

[HM237545.510CD](#)