

515495 FAG

Tapered roller bearings

TYPE: Roller bearings, Tapered, Double row, O-arrangement, inch size, design 2 (FAG)

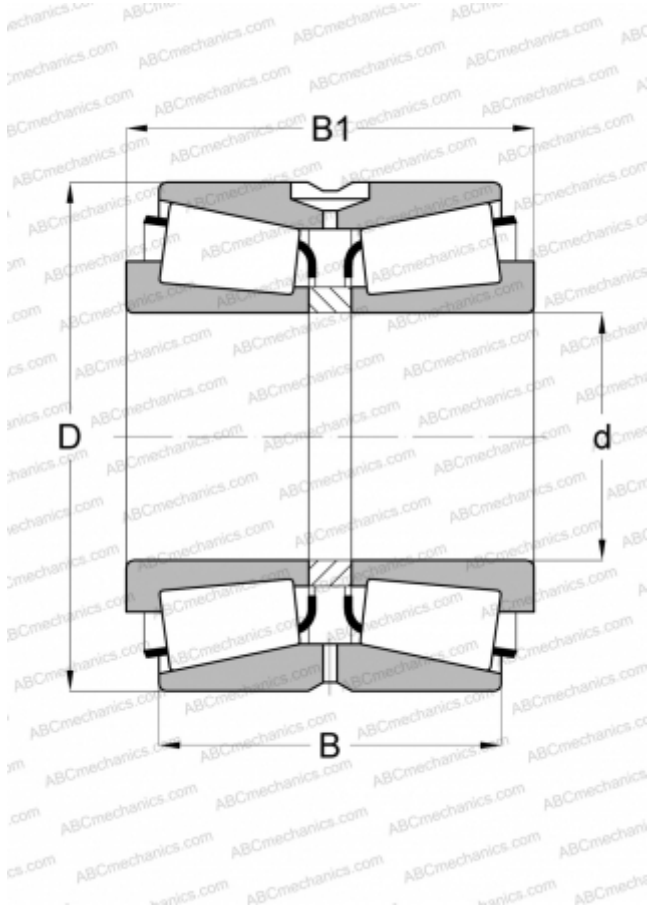

Technical specification

DIMENSIONS, MM

d	330,200
D	482,600
B	177,800
C	127,000

WEIGHT, KG

97,700

MANUFACTURER

[FAG](#)

INTERCHANGE

TIMKEN

[EE526130.191CD](#)