

510608A FAG

Tapered roller bearings

TYPE: Roller bearings, Tapered, Double row, O-arrangement, inch size, design 2 (FAG)

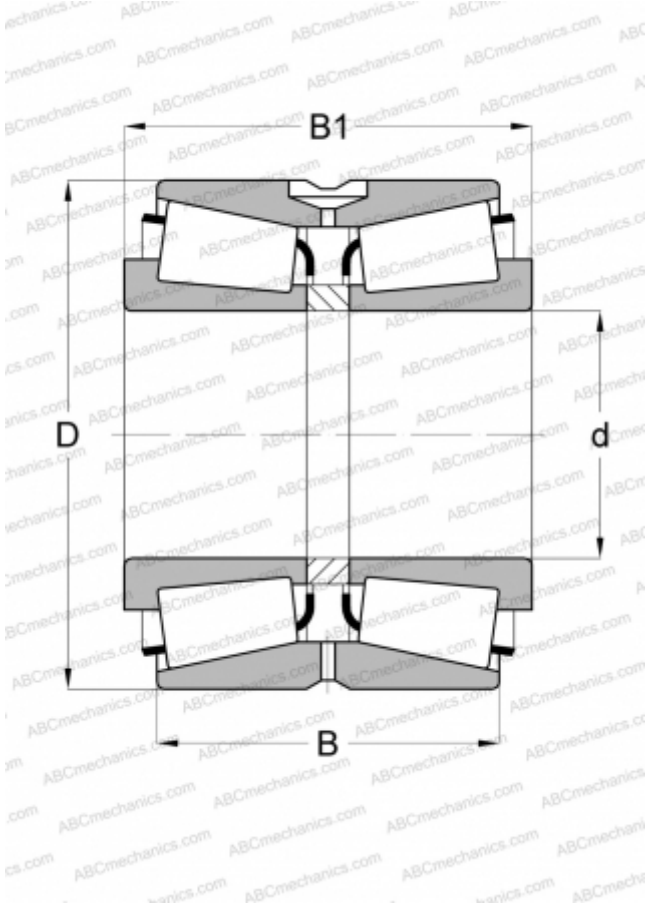

Technical specification

DIMENSIONS, MM

d	355,600
D	501,650
B	155,575
C	107,950

WEIGHT, KG

85,100

MANUFACTURER

[FAG](#)

INTERCHANGE

TIMKEN

[EE231400.976CD](#)