

573335 FAG

Tapered roller bearings

TYPE: Roller bearings, Tapered, Double row, O-arrangement, inch size, design 2 (FAG)

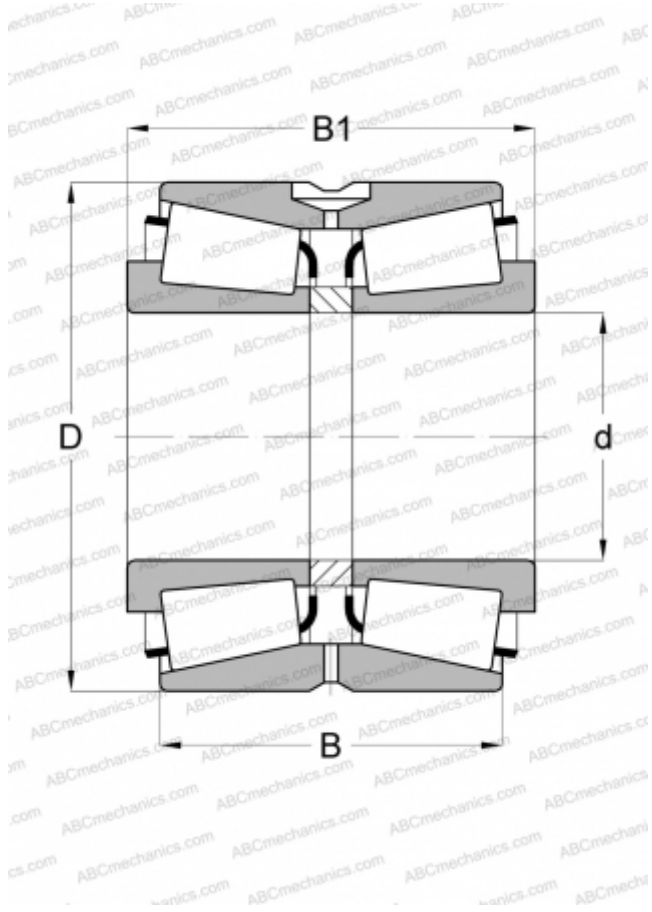

Technical specification

DIMENSIONS, MM

d	368,300
D	596,900
B	203,200
C	133,350

WEIGHT, KG

184,000

MANUFACTURER

[FAG](#)

INTERCHANGE

TIMKEN

[EE181453.351CD](#)