

M268749.710CD TIMKEN

Tapered roller bearings

TYPE: Roller bearings, Tapered, Double row, O-arrangement, inch size, design 2 (FAG)

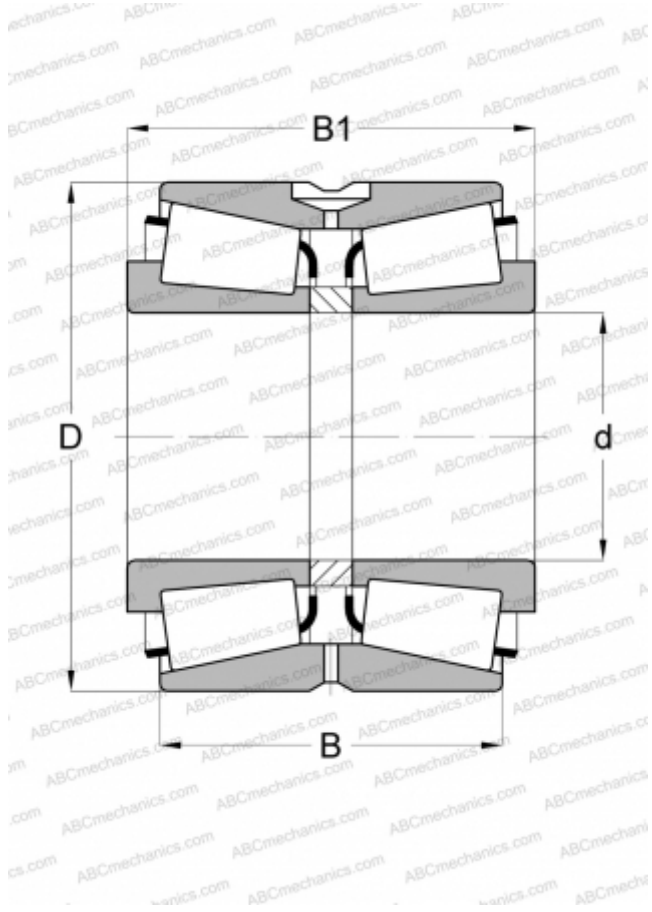

Technical specification

DIMENSIONS, MM

d	415,925
D	590,550
B	244,475
C	193,675

WEIGHT, KG

200,000

MANUFACTURER

[TIMKEN](#)

INTERCHANGE

FAG [517498A](#)