

541705 FAG

Tapered roller bearings

TYPE: Roller bearings, Tapered, Double row, O-arrangement, inch size, design 2 (FAG)

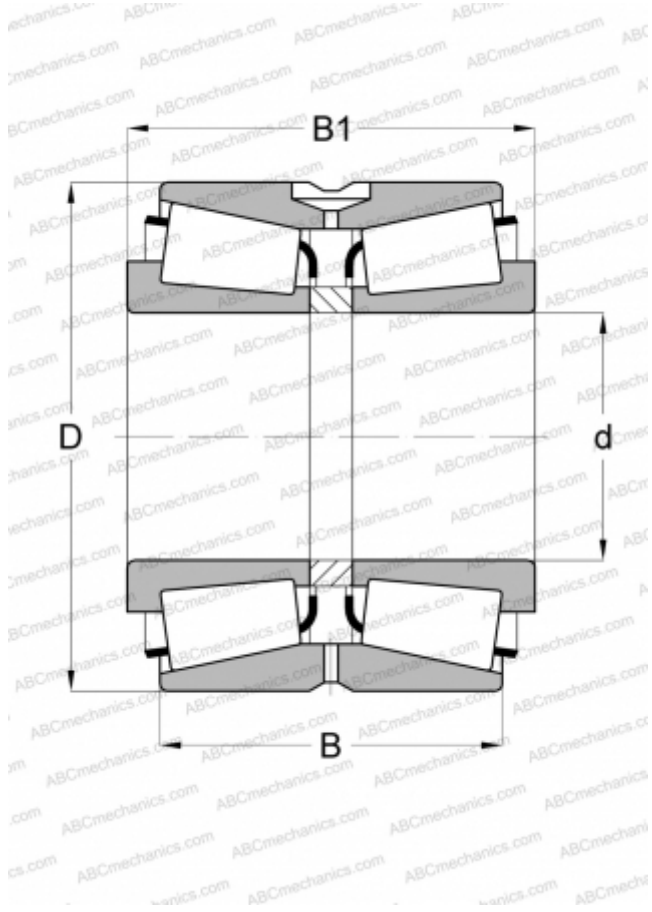

Technical specification

DIMENSIONS, MM

d	457,200
D	660,400
B	228,600
C	171,450

WEIGHT, KG

238,000

MANUFACTURER

[FAG](#)

INTERCHANGE

TIMKEN

[M271648.610CD](#)