

528407 FAG

Tapered roller bearings

TYPE: Roller bearings, Tapered, Double row, O-arrangement, inch size, design 2 (FAG)

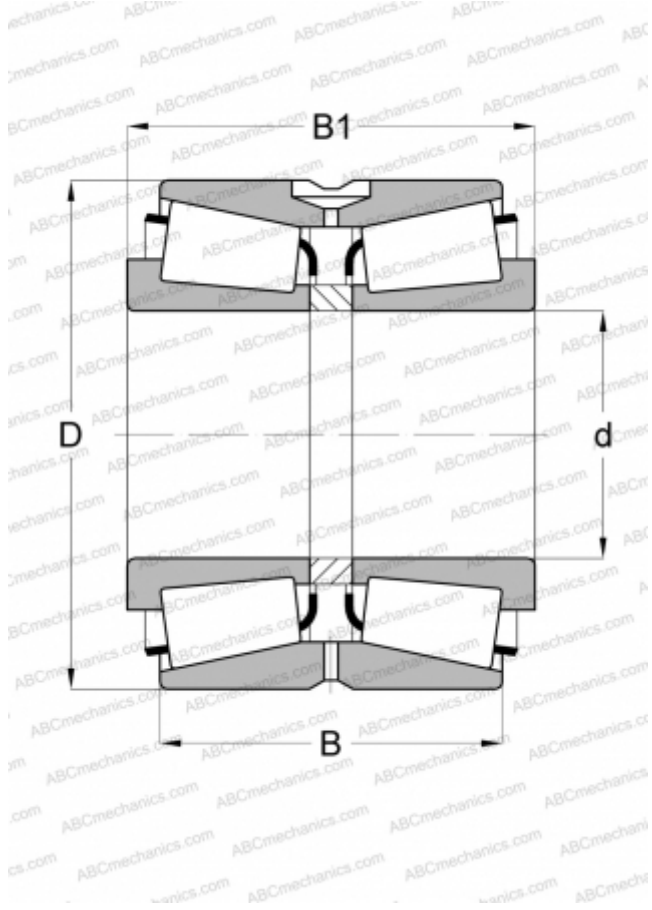

Technical specification

DIMENSIONS, MM

d	520,700
D	736,600
B	186,502
C	114,300

WEIGHT, KG

210,000

MANUFACTURER

[FAG](#)

INTERCHANGE

TIMKEN

[EE982051.901CD](#)