

513974 FAG

Tapered roller bearings

TYPE: Roller bearings, Tapered, Double row, O-arrangement, inch size, design 2 (FAG)

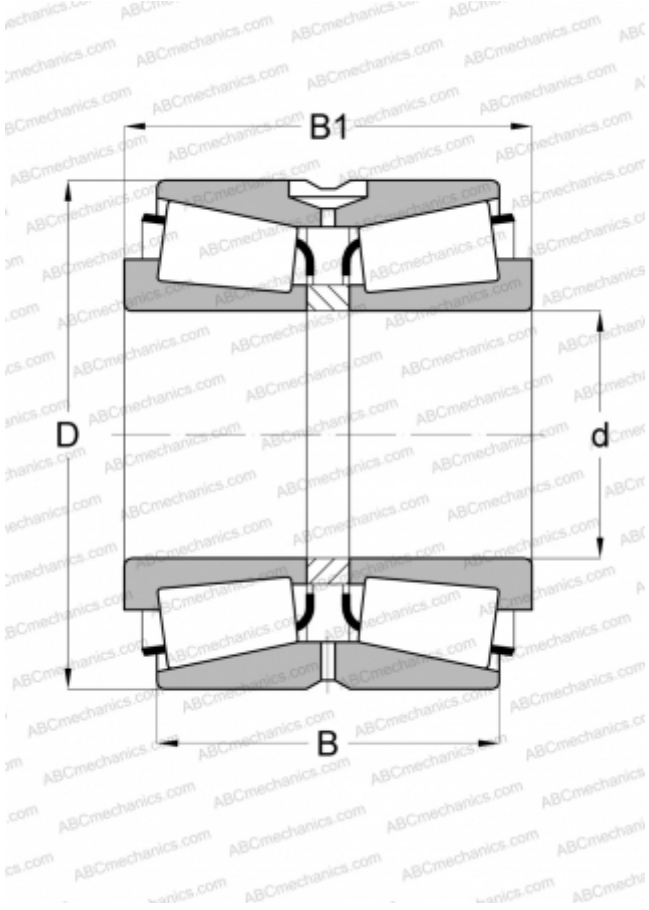

Technical specification

DIMENSIONS, MM

d	609,600
D	787,400
B	206,375
C	158,750

WEIGHT, KG

237,000

MANUFACTURER

[FAG](#)

INTERCHANGE

TIMKEN

[EE649240.311CD](#)