

514502 FAG

Tapered roller bearings

TYPE: Roller bearings, Tapered, Double row, O-arrangement, inch size, design 2 (FAG)

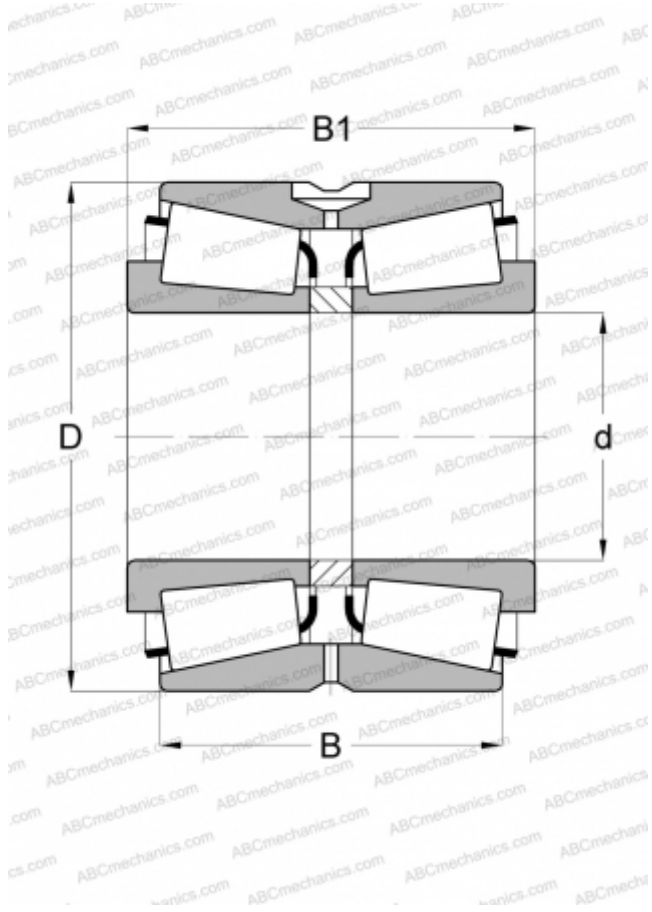

Technical specification

DIMENSIONS, MM

d	660,400
D	812,800
B	203,200
C	158,750

WEIGHT, KG

207,000

MANUFACTURER

[FAG](#)

INTERCHANGE

TIMKEN

[L281148.110CD](#)