

512516 FAG

Tapered roller bearings

TYPE: Roller bearings, Tapered, Double row, O-arrangement, inch size, design 2 (FAG)

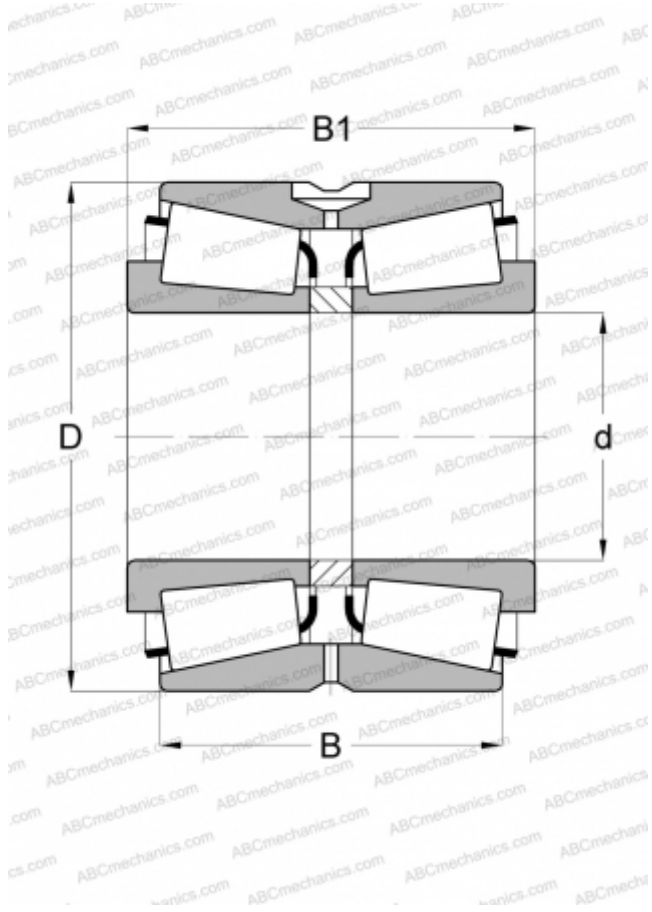

Technical specification

DIMENSIONS, MM

d	685,800
D	876,300
B	200,025
C	152,400

WEIGHT, KG

275,000

MANUFACTURER

[FAG](#)

INTERCHANGE

TIMKEN

[EE655270.346CD](#)