

563113 FAG

Tapered roller bearings

TYPE: Roller bearings, Tapered, Double row, O-arrangement, inch size, design 3 (FAG)

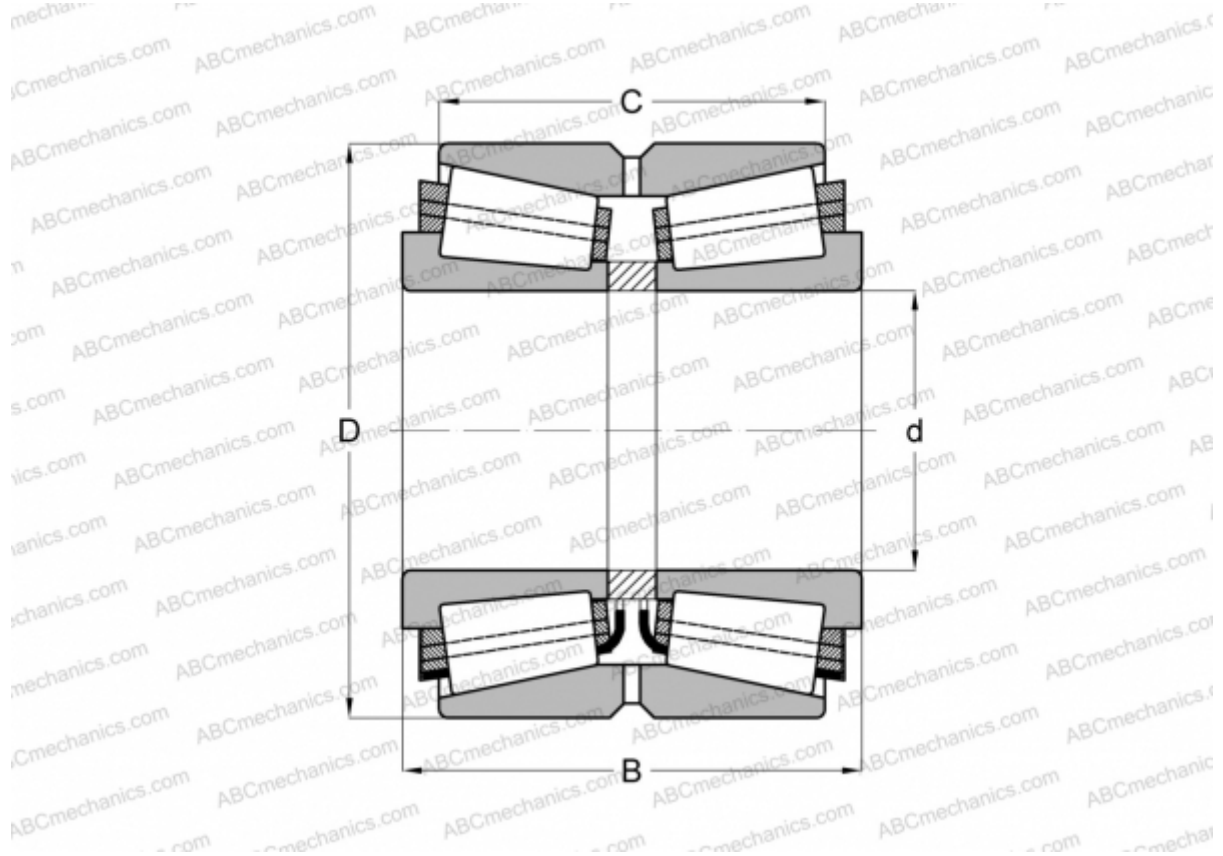

Technical specification

DIMENSIONS, MM

d	1320,800
D	1727,200
B	412,750
C	254,000

WEIGHT, KG 2365,000

MANUFACTURER [FAG](#)