

581099 FAG

Tapered roller bearings

TYPE: Roller bearings, Tapered, Double row, O-arrangement, inch size, design 4 (FAG)

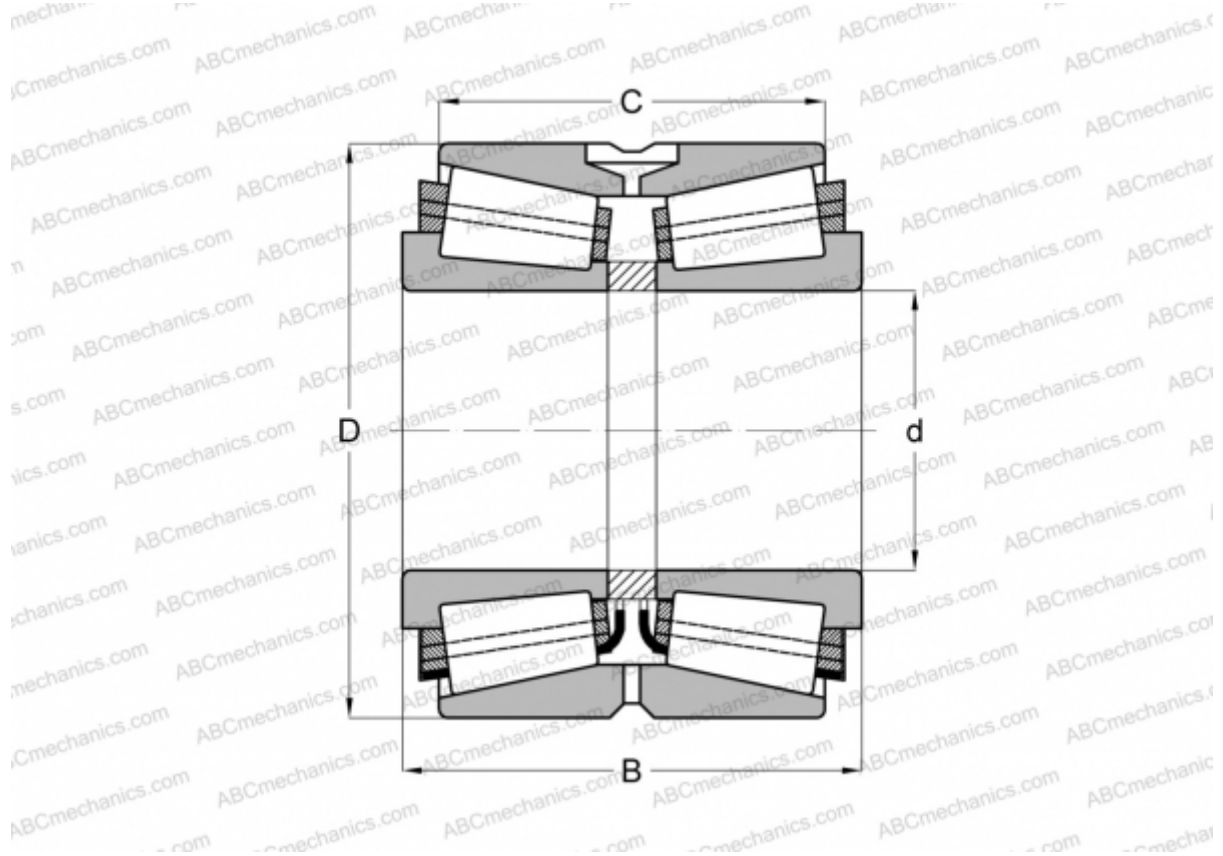

Technical specification

DIMENSIONS, MM

d	368,249
D	523,875
B	214,312
C	169,862

WEIGHT, KG 141,000

MANUFACTURER [FAG](#)

INTERCHANGE

TIMKEN [HM265049.010CD](#)