

HM265049.010CD TIMKEN

Tapered roller bearings

TYPE: Roller bearings, Tapered, Double row, O-arrangement, inch size, design 4 (FAG)

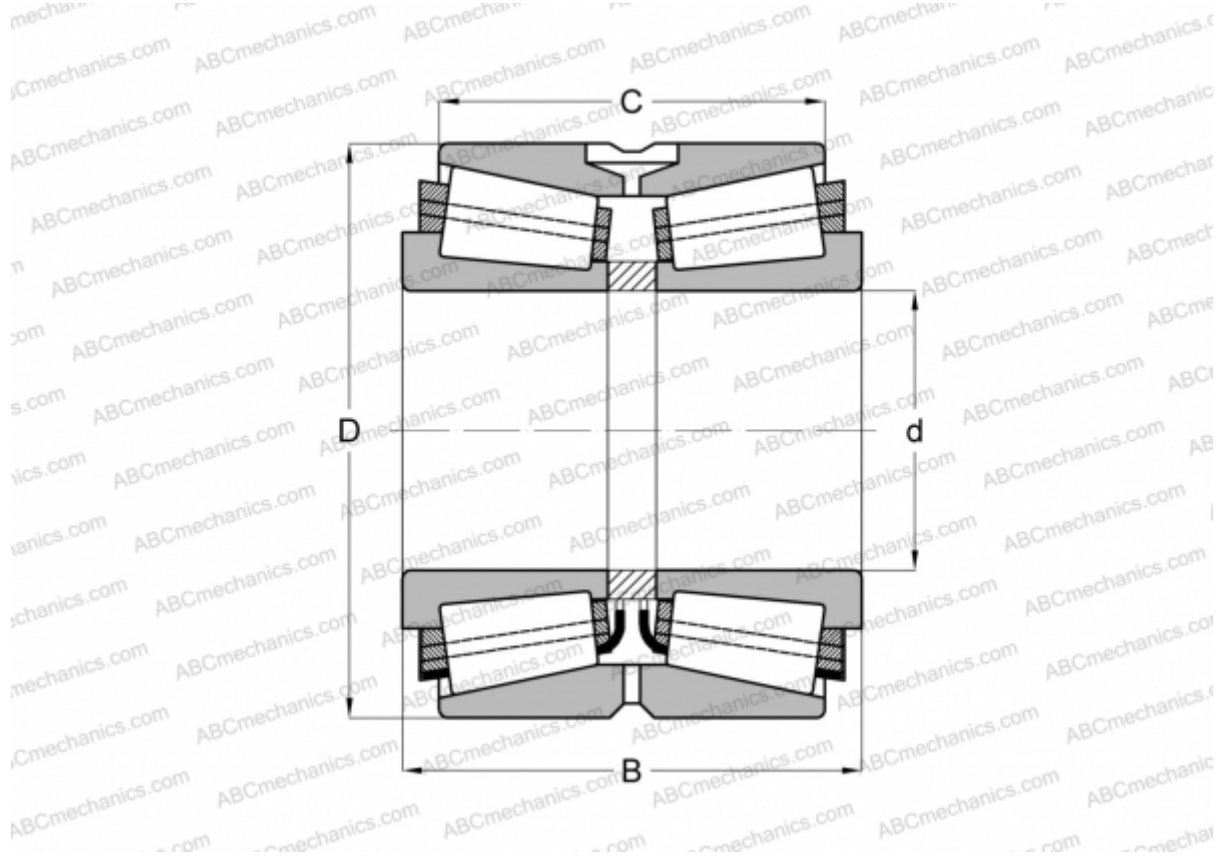

Technical specification

DIMENSIONS, MM

d	368,249
D	523,875
B	214,312
C	169,862

WEIGHT, KG 141,000

MANUFACTURER [TIMKEN](#)

INTERCHANGE

FAG [581099](#)