

M268730.710CD TIMKEN

Tapered roller bearings

TYPE: Roller bearings, Tapered, Double row, O-arrangement, inch size, design 4 (FAG)

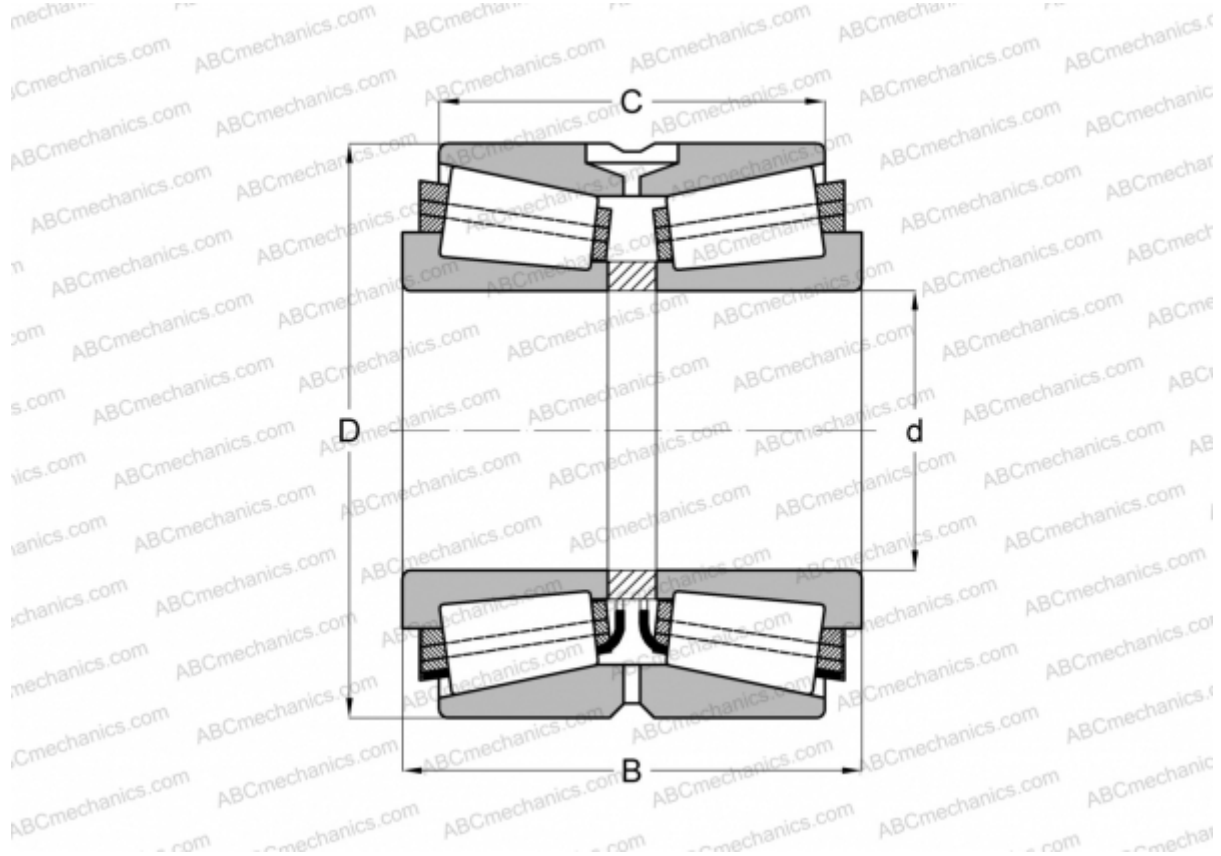

Technical specification

DIMENSIONS, MM

d	381,000
D	590,550
B	244,475
C	193,675

WEIGHT, KG 247,000

MANUFACTURER [TIMKEN](#)

INTERCHANGE

FAG [581097](#)