

HM266449.410CD TIMKEN

Tapered roller bearings

TYPE: Roller bearings, Tapered, Double row, O-arrangement, inch size, design 4 (FAG)

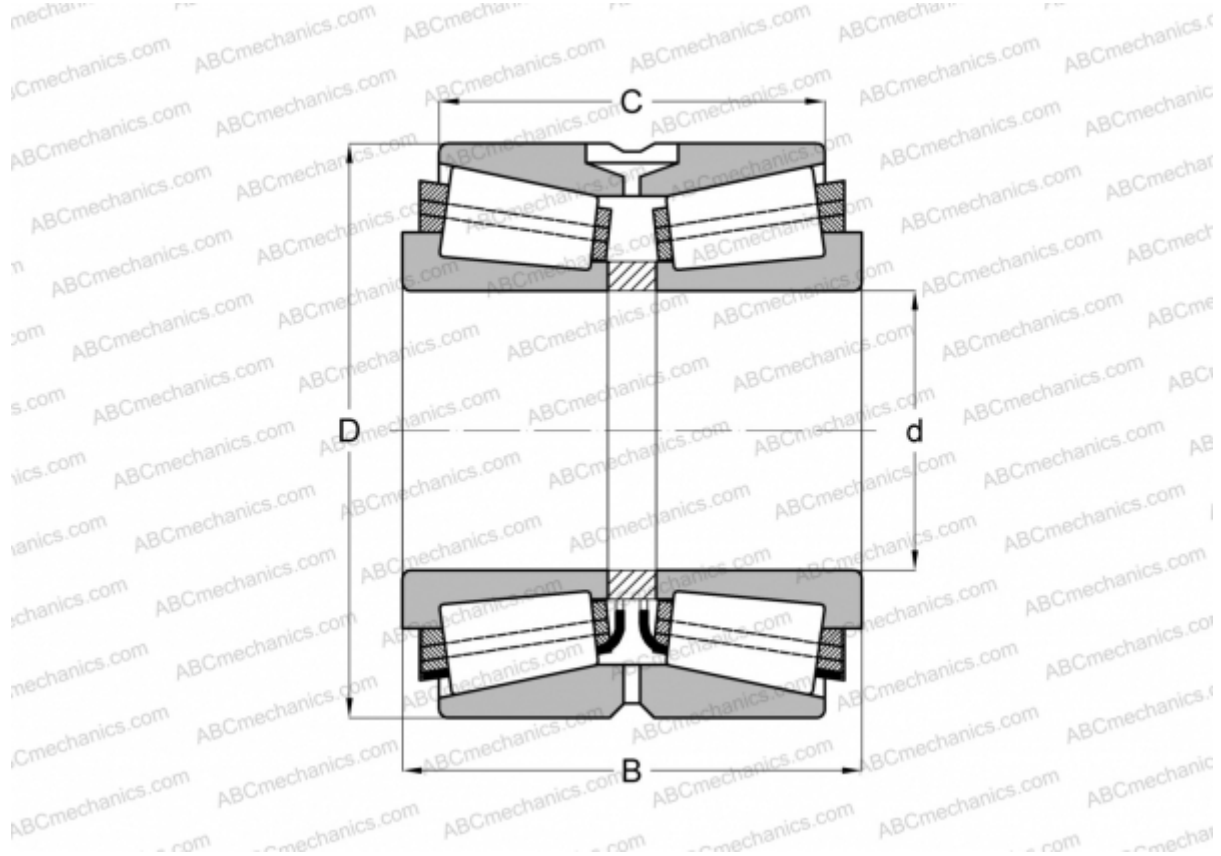

Technical specification

DIMENSIONS, MM

d	384,175
D	546,100
B	222,250
C	177,800

WEIGHT, KG 159,000

MANUFACTURER [TIMKEN](#)

INTERCHANGE

FAG [579745](#)