

578129 FAG

Tapered roller bearings

TYPE: Roller bearings, Tapered, Double row, O-arrangement, inch size, design 4 (FAG)

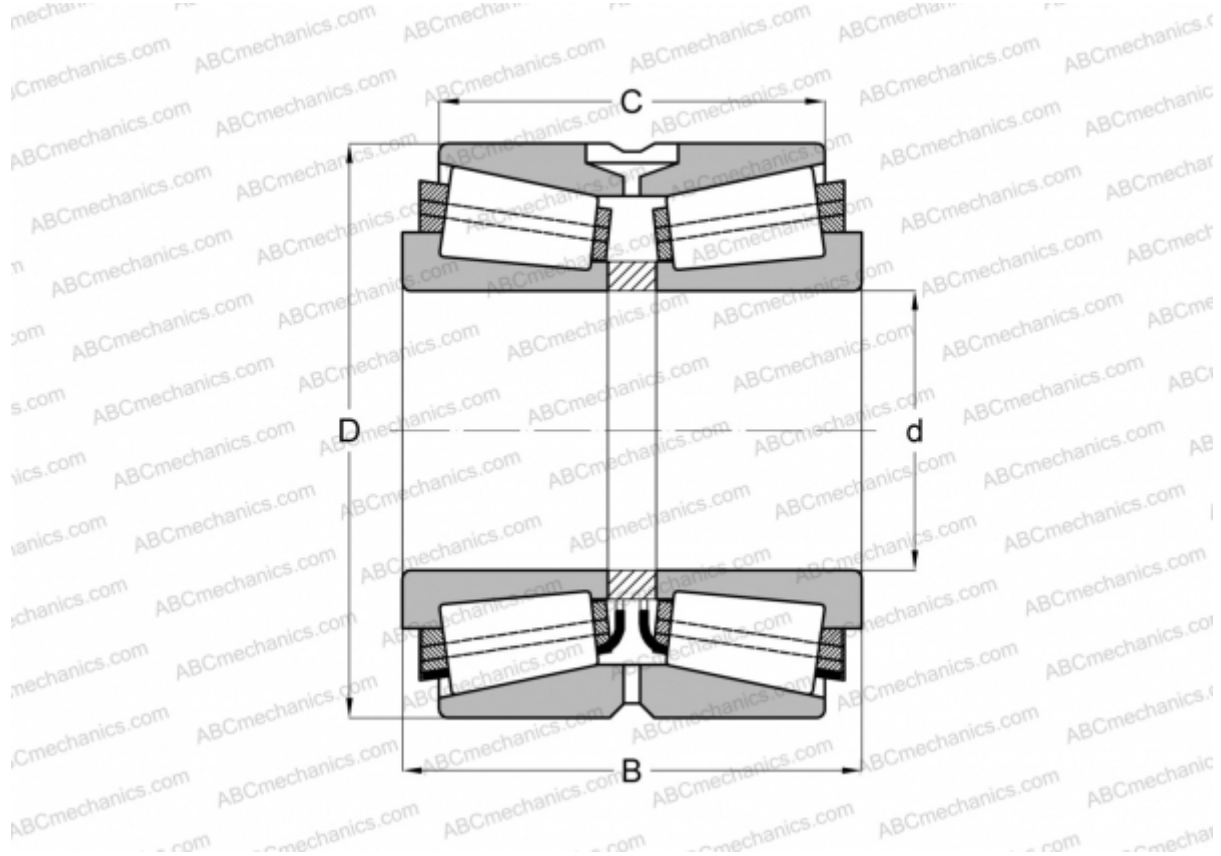

Technical specification

DIMENSIONS, MM

d	415,925
D	590,550
B	244,475
C	193,675

WEIGHT, KG 205,000

MANUFACTURER [FAG](#)

INTERCHANGE

TIMKEN [M268749.710CD](#)