

M272749.710CD TIMKEN

Tapered roller bearings

TYPE: Roller bearings, Tapered, Double row, O-arrangement, inch size, design 4 (FAG)

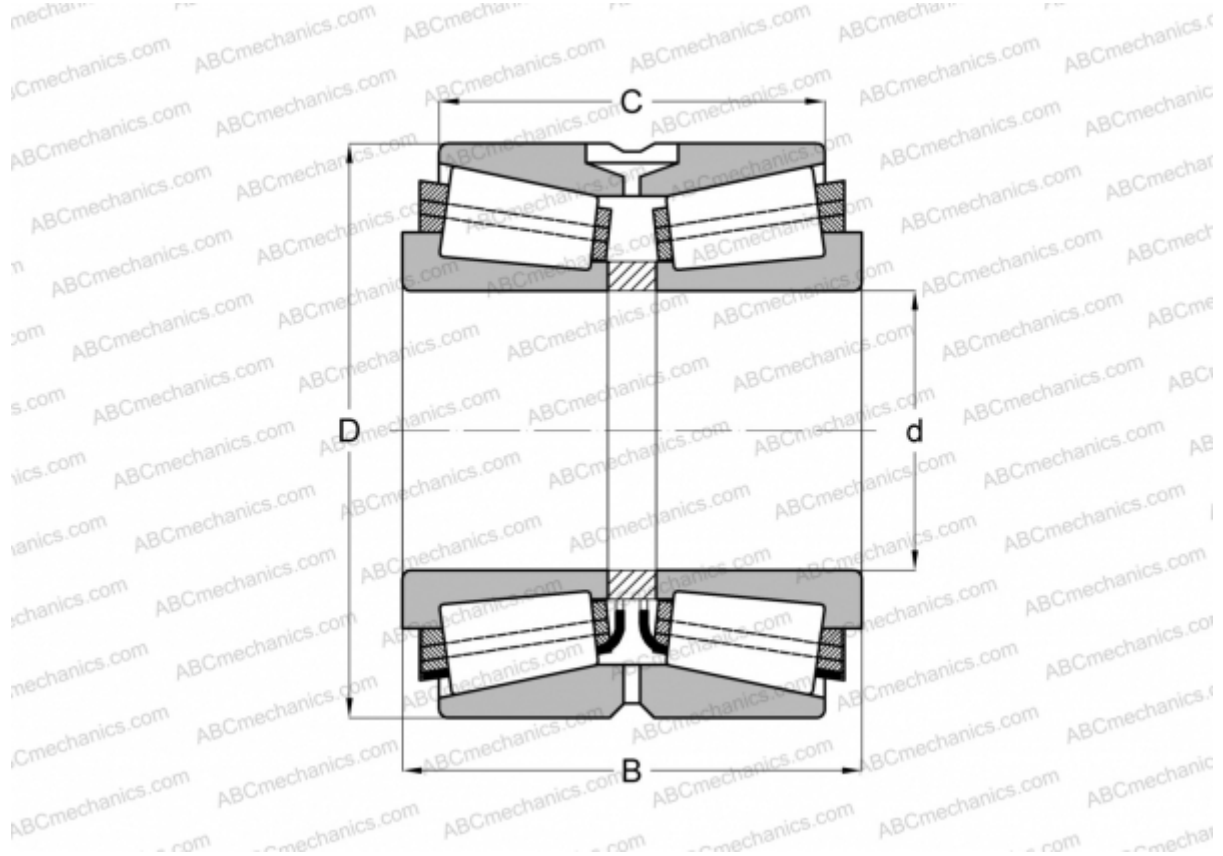

Technical specification

DIMENSIONS, MM

d	479,425
D	679,450
B	276,225
C	222,250

WEIGHT, KG 304,000

MANUFACTURER [TIMKEN](#)

INTERCHANGE

FAG [578647](#)