

568648 FAG

Tapered roller bearings

TYPE: Roller bearings, Tapered, Double row, O-arrangement, metric size, design 1 (FAG)

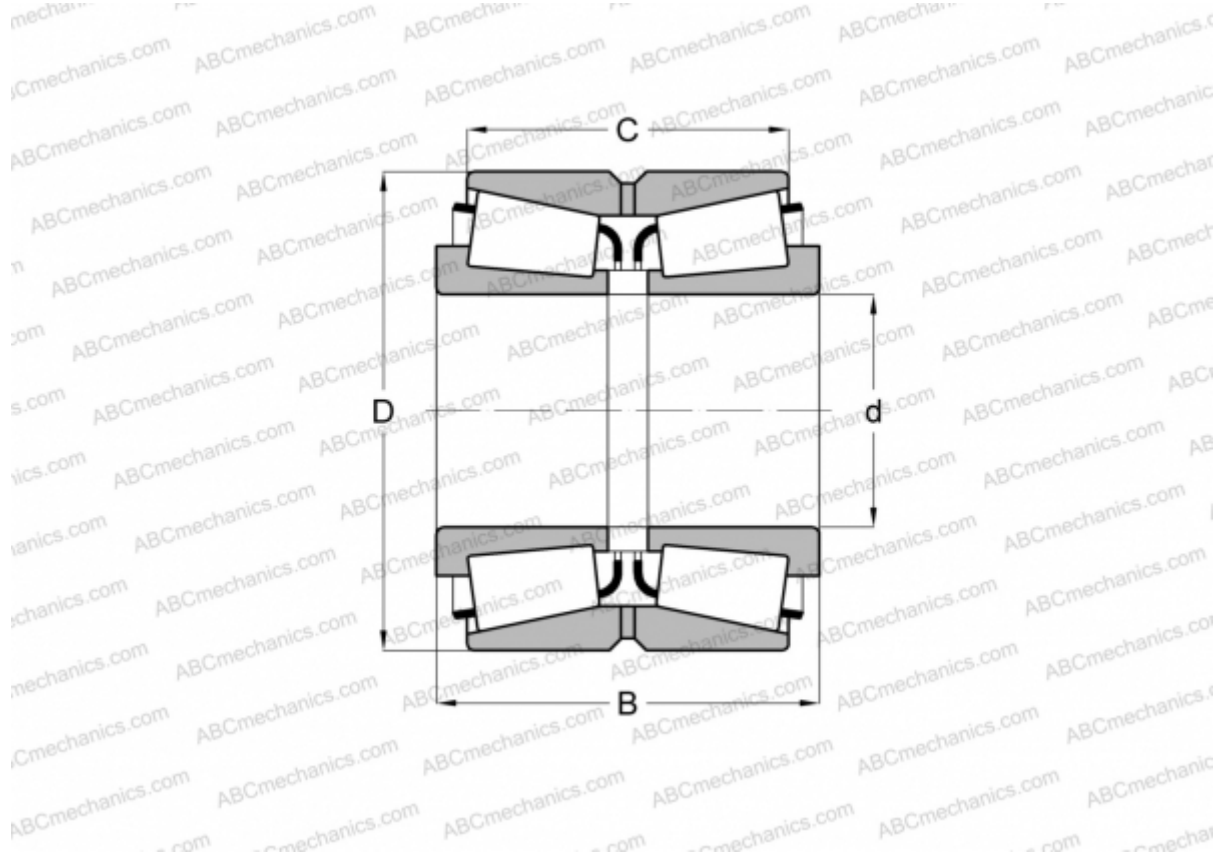

Technical specification

DIMENSIONS, MM

d	240,000
D	320,000
B	110,000
C	87,000

WEIGHT, KG 22,300

MANUFACTURER [FAG](#)