

511987 FAG

Tapered roller bearings

TYPE: Roller bearings, Tapered, Double row, O-arrangement, metric size, design 1 (FAG)

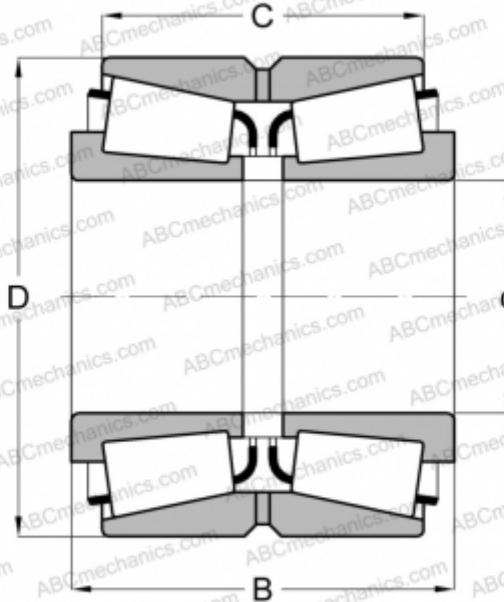

Technical specification

DIMENSIONS, MM

d	260,000
D	360,000
B	134,000
C	108,000

WEIGHT, KG 39,200

MANUFACTURER [FAG](#)