

538180 FAG

Tapered roller bearings

TYPE: Roller bearings, Tapered, Double row, O-arrangement, metric size, design 1 (FAG)

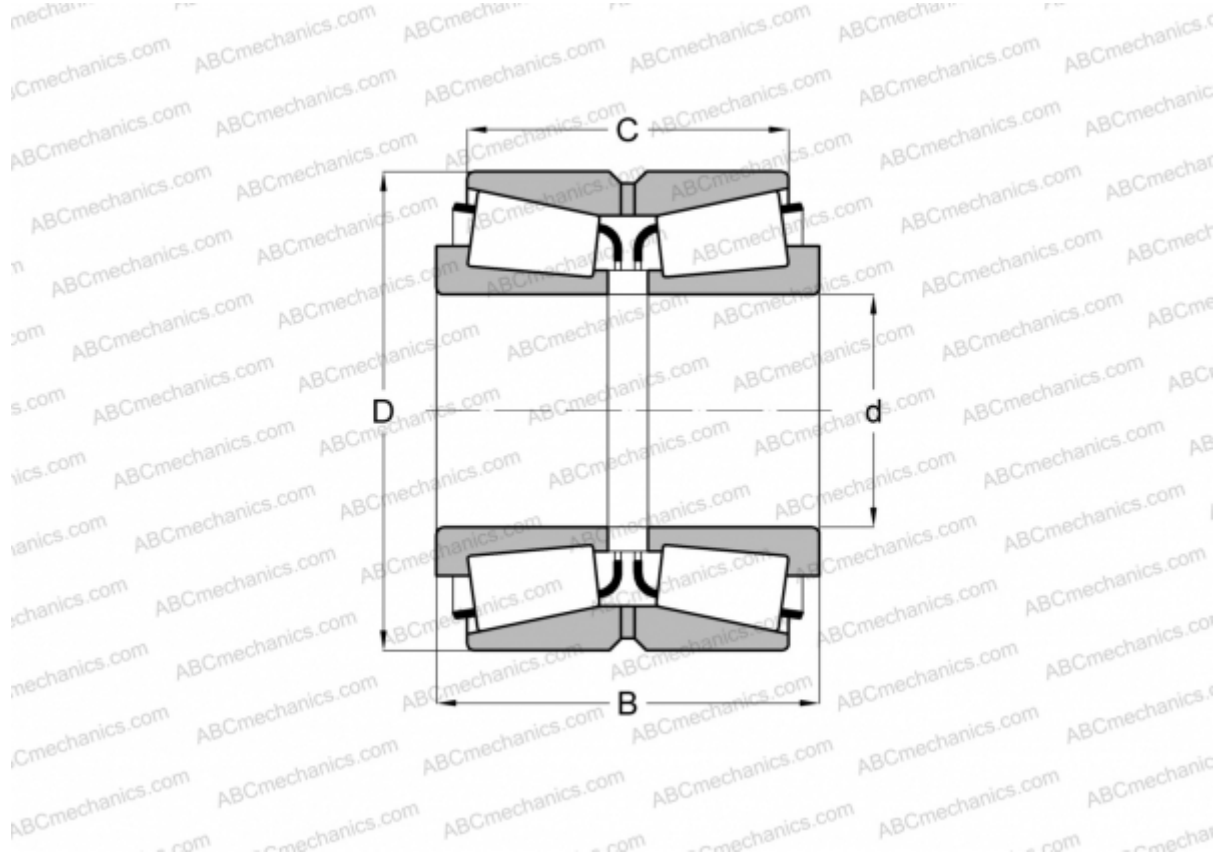

Technical specification

DIMENSIONS, MM

d	280,000
D	420,000
B	189,000
C	154,000

WEIGHT, KG 85,200

MANUFACTURER [FAG](#)