

## 511994 FAG

Tapered roller bearings

TYPE: Roller bearings, Tapered, Double row, O-arrangement, metric size, design 1 (FAG)

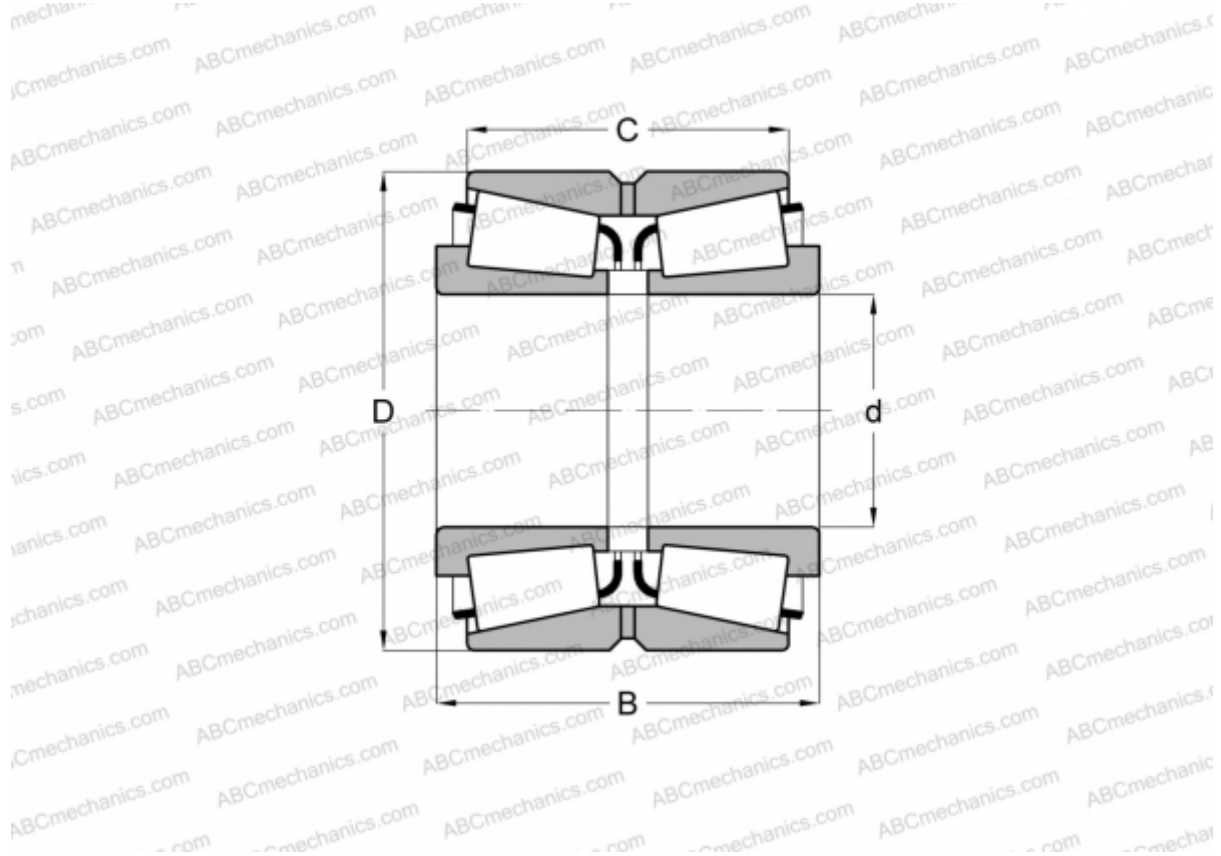

### Technical specification

#### DIMENSIONS, MM

d	380,000
D	620,000
B	242,000
C	170,000

**WEIGHT, KG** 251,000

**MANUFACTURER** [FAG](#)