

565736 FAG

Tapered roller bearings

TYPE: Roller bearings, Tapered, Double row, O-arrangement, metric size, design 1 (FAG)

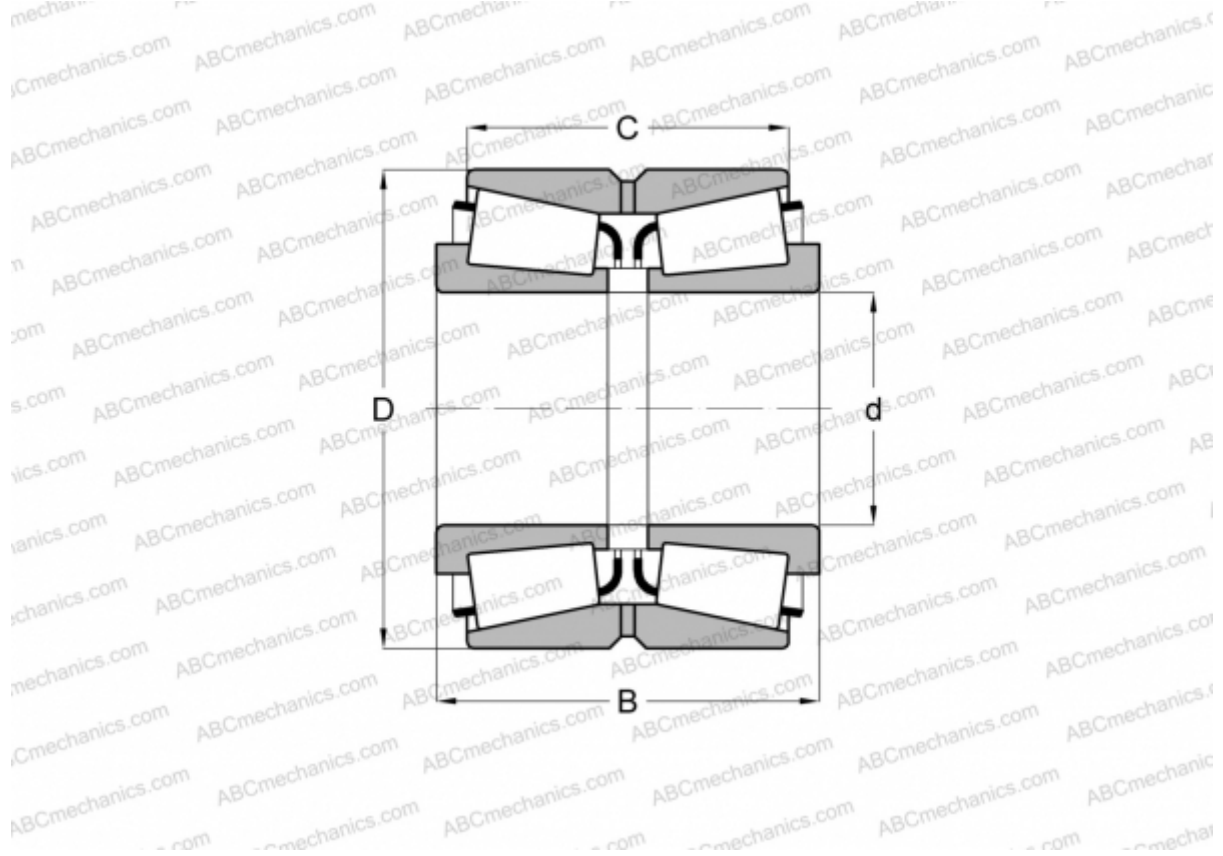

Technical specification

DIMENSIONS, MM

d	400,000
D	590,000
B	185,000
C	125,000

WEIGHT, KG 146,000

MANUFACTURER [FAG](#)