

549970 FAG

Tapered roller bearings

TYPE: Roller bearings, Tapered, Double row, O-arrangement, metric size, design 2 (FAG)

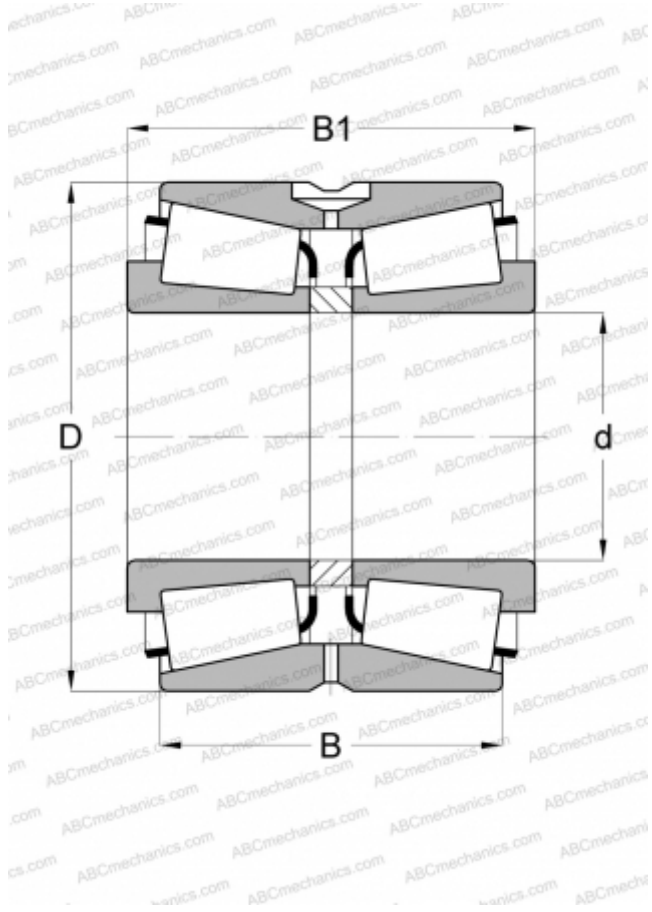

Technical specification

DIMENSIONS, MM

d	105,000
D	190,000
B	118,000
C	96,000

WEIGHT, KG

14,800

MANUFACTURER

[FAG](#)