

511978 FAG

Tapered roller bearings

TYPE: Roller bearings, Tapered, Double row, O-arrangement, metric size, design 2 (FAG)

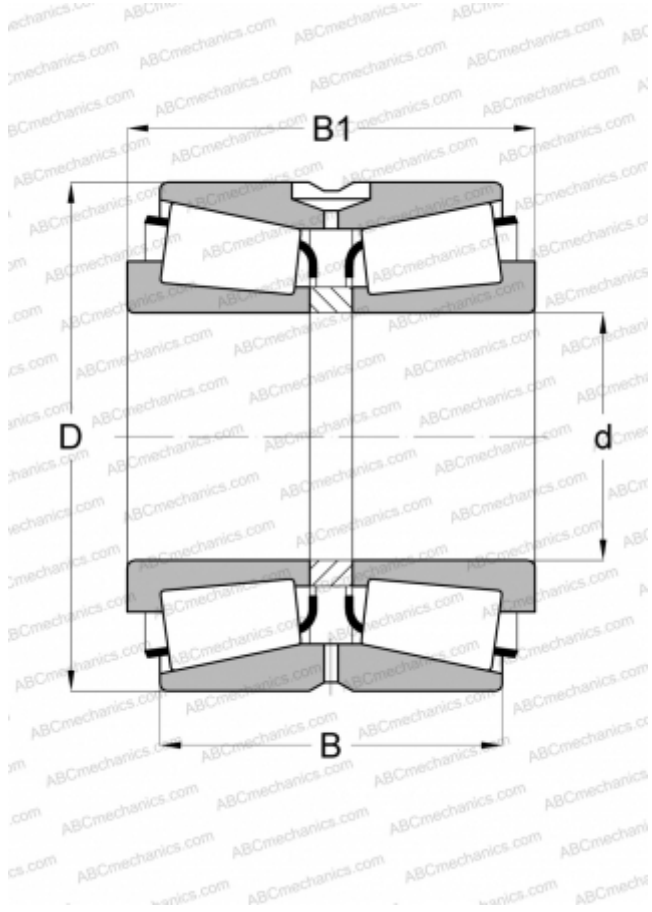

Technical specification

DIMENSIONS, MM

d	180,000
D	280,000
B	134,000
C	108,000

WEIGHT, KG

30,200

MANUFACTURER

[FAG](#)