

511980 FAG

Tapered roller bearings

TYPE: Roller bearings, Tapered, Double row, O-arrangement, metric size, design 2 (FAG)

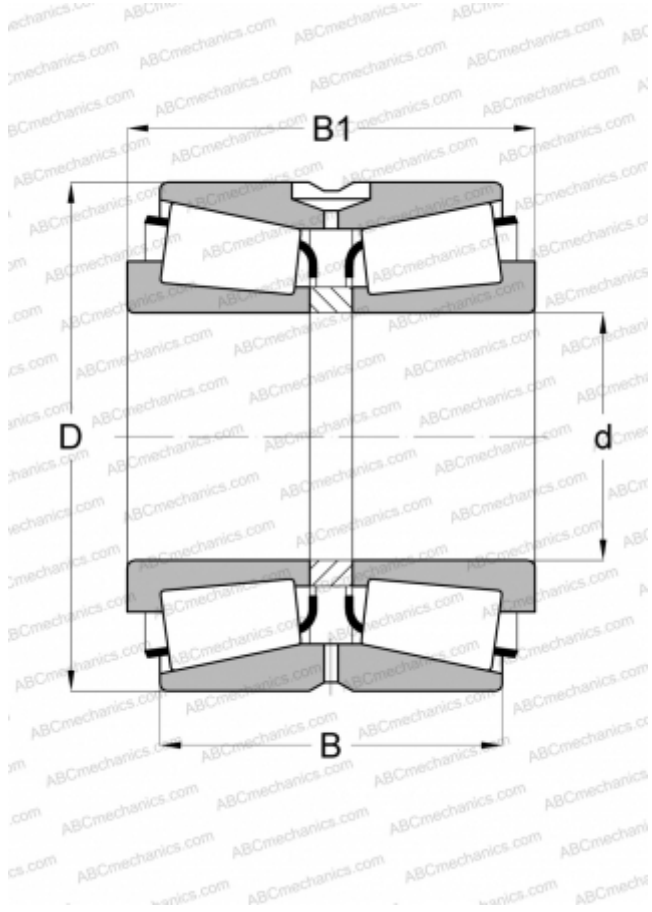

Technical specification

DIMENSIONS, MM

d	190,000
D	260,000
B	95,000
C	76,000

WEIGHT, KG

13,500

MANUFACTURER

[FAG](#)