

538178 FAG

Tapered roller bearings

TYPE: Roller bearings, Tapered, Double row, O-arrangement, metric size, design 2 (FAG)

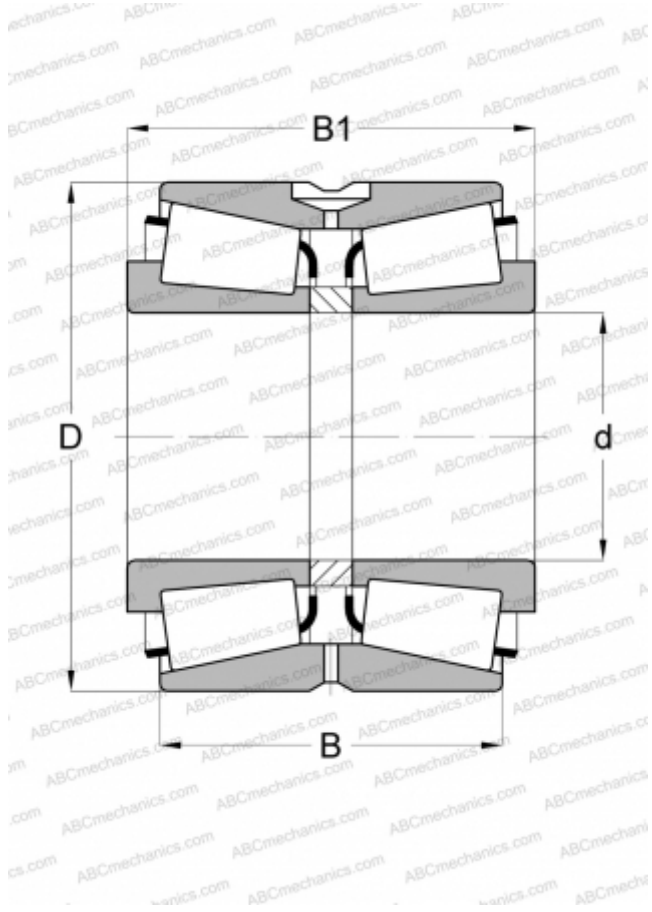

Technical specification

DIMENSIONS, MM

d	200,000
D	280,000
B	117,000
C	97,000

WEIGHT, KG

21,600

MANUFACTURER

[FAG](#)